

TELESCOPIC

ACCESSORIES

PSU-034B Truss support for TE-034 towerlift

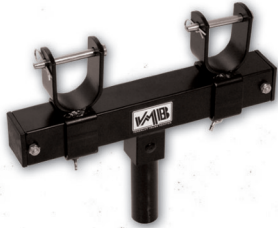

PSU-06B Adjustable support for truss, with U-piece and pin. Suitable for towerlifts with insertion of 35 mm.
Also available in silver color, ref.: PSU-06



PSU-074B TE-074 adjustable support for truss, with U-piece and pin. Insertion of 55 mm. Also available in silver color, ref.: PSU-074



PSU-086B TE-086 adjustable support for truss, with U-piece and pin. Insertion of 50 mm



PSA-01 Adjustable support for truss, with tilting alicraft grips. For towerlifts with insertion of 35 mm

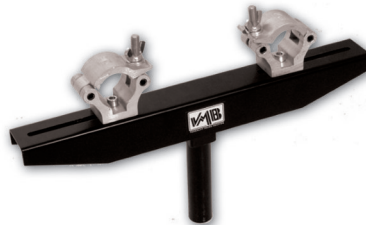

PSA-02 Adjustable support for truss, with tilting alicraft grips. For towerlifts with insertion of 55 mm



PSX-01 Adjustable 4 point alicraft support with insertion of 35 mm

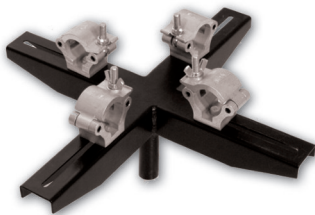

PSX-02 Adjustable 4 point alicraft support with insertion of 55 mm

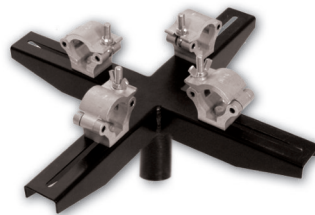

PSD-01 Flat truss support for towerlifts with insertion of 35 mm



PSU-034B



PSA-01



PSD-01

BT-06 Support bar with length of 1.89 m. Suitable for all towerlifts with insertion of 35 mm



BT-07 TE-074 support bar with length of 1.89 m. Insertion of 55 mm



BT-061 Support for lights bar. Suitable for towerlifts with insertion of 35 mm



BT-071 TE-074 support for lights bar. Insertion of 55 mm



BT-072 TE-074 support for two lights bar. Insertion of 55 mm

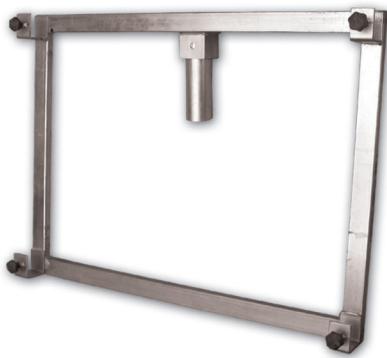

BT-062 Support for two lights bars. Suitable for all towerlifts with insertion of 35 mm

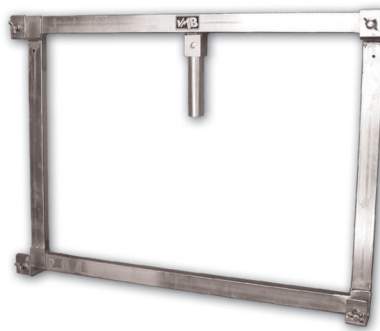

SPG-3529 Adaptor for Spigot with insertion of 29 mm. Suitable for towerlift insertion of 35 mm



TE-074 adaptor for Spigot with insertion of 29 mm. Towerlift insertion of 55 mm

SPG-5529

AT-01 Alicraft, suitable for towerlifts with insertion of 35 mm



RH-1 Transport kit

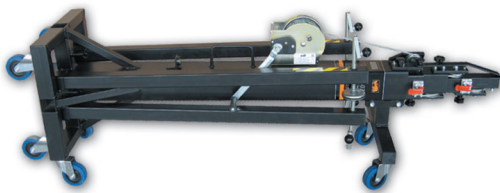

AT-02

Alicraft, suitable for towerlifts with insertion of 55 mm

SPK-35

35 mm insertion for speaker placement



PSX-01



BT-06

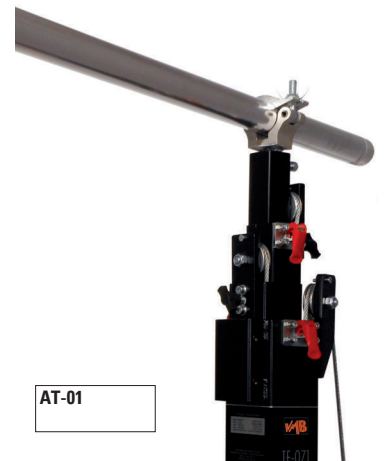

AT-01