

AIP1640

LED Control Dedicated Circuit

Product Introduction

1. Overview

It is a dedicated circuit for LED driving control (LED Display) with integrated MCU digital ports, data latch, LED high voltage driver and other circuits. This product has excellent performance and reliable quality. It is mainly applied to display drive of small household appliances and electronic scales.

Features:

- CMOS process
- Brightness adjustment circuit (duty cycle 8 levels adjustable)
- Two-wire serial interface (CLK, DIN)
- Oscillation mode: Built-in RC oscillation (450KHz+5%)
- Built-in power-on reset circuit
- Built-in automatic blanking circuit
- Display mode (8 segments × 16 bits), support common cathode digital tube output
- Package: SOP28

2. Functional Diagram and Pin Description

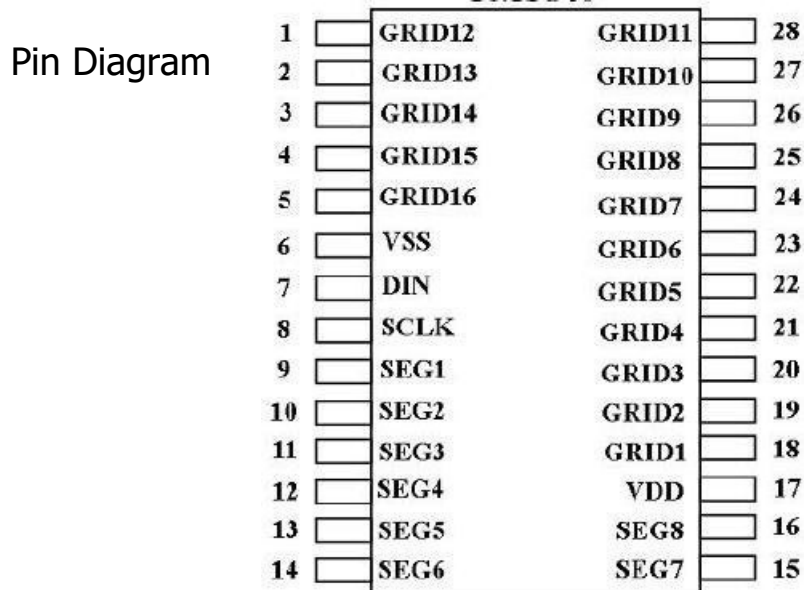

Pin Description And Structure Schematic

Pin	Name	Symbol	Description
1	Output(bits)	GRID12	Bits output, N tube Open drain output
2	Output(bits)	GRID13	Bits output, N tube Open drain output
3	Output(bits)	GRID14	Bits output, N tube

			Open drain output
4	Output(bits)	GRID15	Bits output, N tube Open drain output
5	Output(bits)	GRID16	Bits output, N tube Open drain output
6	Logically	VSS	Connect to GMD
7	Data input	DIN	Serial data input, input data changes at Low level of SCLK , transmitted at high level of SCLK
8	Clock input	SCLK	Enter data on the rising edge
9	Output (segment)	SEG1	Segment output, P tube open drain output

10	Output (segment)	SEG2	Segment output, P tube open drain output
11	Output (segment)	SEG3	Segment output, P tube open drain output
12	Output (segment)	SEG4	Segment output, P tube open drain output
13	Output (segment)	SEG5	Segment output, P tube open drain output
14	Output (segment)	SEG6	Segment output, P tube open drain output
15	Output (segment)	SEG7	Segment output, P tube open drain output

16	Output (segment)	SEG8	Segment output, P tube open drain output
17	Logic power supply	VDD	5V ± 10%
18	Output(bits)	GRID1	Bits output, N tube Open drain output
19	Output(bits)	GRID2	Bits output, N tube Open drain output
20	Output(bits)	GRID3	Bits output, N tube Open drain output
21	Output(bits)	GRID4	Bits output, N tube Open drain output
22	Output(bits)	GRID5	Bits output, N tube Open drain output

23	Output(bits)	GRID6	Bits output, N tube Open drain output
24	Output(bits)	GRID7	Bits output, N tube Open drain output
25	Output(bits)	GRID8	Bits output, N tube Open drain output
26	Output(bits)	GRID9	Bits output, N tube Open drain output
27	Output(bits)	GRID10	Bits output, N tube Open drain output
28	Output(bits)	GRID11	Bits output, N tube Open drain output

3. Electrical Property

Limit parameters ($T_{amb}=25^{\circ}C$, $V_{ss} = 0V$ unless otherwise specified)

Parameter Name	Symbol	Condition	Rated value	Unit
Power supply voltage	VCC		-0.5 ~ +7.0	V
Logic input voltage	VI1		-0.5~VDD+0.5	V
LED Seg Drive Output Current	IO1		-50	mA
LED Grid drive output current	IO2		+200	mA
Power loss	PD		400	mW
Working temperature	Topt		-40~+85	°C
Storage temperature	Tstg		-65~+150	°C
Welding temperature	TL	10s	250	°C

Recommended Conditions ($T_a = -40\sim+85^{\circ}\text{C}$, $V_{ss} = 0\text{V}$)

Parameter name	Symbol	Minimum	Typical	Maximum	Unit
Logic supply voltage	VDD		5		V
High level input voltage	V_{IH}	$0.7V_{DD}$	-	VDD	V
Low level input voltage	V_{IL}	0	-	$0.3V_{DD}$	V

Electrical Characteristics

Electrical Characteristics ($T_a = -40\sim+85^{\circ}\text{C}$, $V_{DD} = 4.5\text{V}\sim 5.5\text{V}$, $GND = 0\text{V}$)

Parameter name	Symbol	Test Condition	Minimum	Typical	Maximum	Unit
High level output current	Ioh1	GRID1~GRID1 6, Vo = vdd-2V	-20	-25	-40	mA
	Ioh2	GRID1~GRID1 6, Vo = vdd-3V	-20	-30	-50	mA
Low level output current	IOL1	SEG1~SEG8 Vo=0.3V	80	140	-	mA
Low level output current	Idout	VO = 0.4V, dout	4	-	-	mA
High level output current tolerance	Itolsg	VO = VDD - 3V, GRID1~ GRID16 -	-	-	5	%
Input Current	II	VI = VDD / VSS	-	-	±1	μA

High level input voltage	V _{IH}	CLK, DIN	0.7V _{DD}	-		V
Low level input voltage	V _{IL}	CLK, DIN	-	-	0.3V _{DD}	V
Hysteretic voltage	V _H	CLK, DIN	-	0.35	-	V
Dynamic current loss	I _{DDdyn}	No load, display off	-	-	5	MA

Switch Characteristics (unless otherwise specified, T_{amb} = -40~+85°C, V_{DD}= 4.5 ~ 5.5V)

Parameter Name	Symbol	Test Condition	Minimum	Typical	Maximum	Unit
Oscillating frequency	F _{osc}		-	450	-	KHz

Transmission delay time	tPLZ	CLK → DIO CL = 15pF, RL = 10K Ω	-	-	300	ns
	tPZL		-	-	100	
Rise Time	TTZH 1	GRID1~ GRID16 CL =300p F	-	-	2	μs
	TTZH 2	SEG1~ SEG8 CL =300p F	-	-	0.5	μs
Fall time	TTHZ	CL = 300pF, Segn, Gridn	-	-	120	μs
Maximum clock frequency	Fmax	Duty Cycle 50%	1	-	-	MHZ
Input capacitance	CI	-	-	-	15	pF

Clock Characteristics (Tamb=-40~+85°C, VDD= 4.5 ~ 5.5V unless otherwise specified)

Parameter Name	Symbol	Test Condition	Minimum	Typical	Maximum	Unit
Clock Pulse Width	PWCLK	-	400	-	-	ns
Strobe Width	PWSTB	-	1	-	-	μs
Data Building-up Time	tSETUP	-	100	-	-	ns
Data Retention Time	tHOLD	-	100	-	-	ns
Waiting Time	tWAIT	CLK↑→CLK↓	1	-	-	μs

Interface Description

Microprocessor data communicates via the AIP1640 and two-wire bus interface. When CLK is high level and inputting data, the signal on DIN must be remained unchanged. Only when the clock signal on CLK is low level, the signal on DIN can be changed. The input of data is always low bit first and the high bit is transmitted later. The start condition of data input is when CLK is high level, DIN changes from low level to high level; the end condition is when CLK is high level, DIN changes from low level to high level.

The instruction data transmission process is as follows:

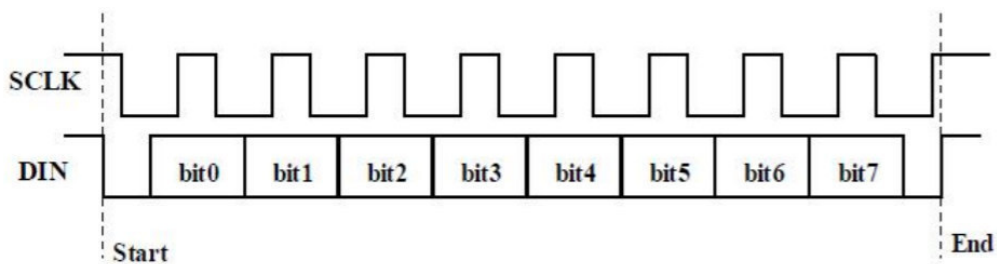

Instruction Data Transmission Format

Write SRAM data address automatically added 1 mode:

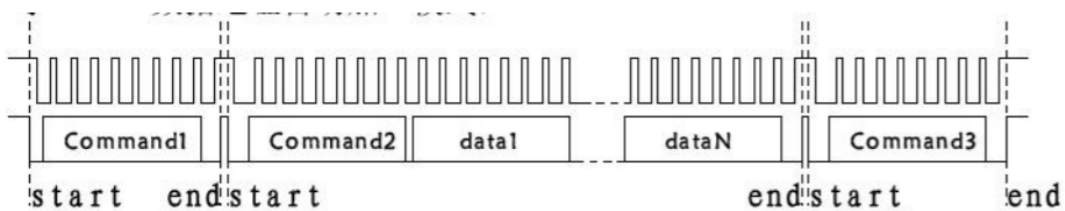

Automatic address write data format

Command1: Setting data

Command2: Setting address

Data1~N: Transfer display data

Command3: Control display

Write SRAM data fixed address mode:

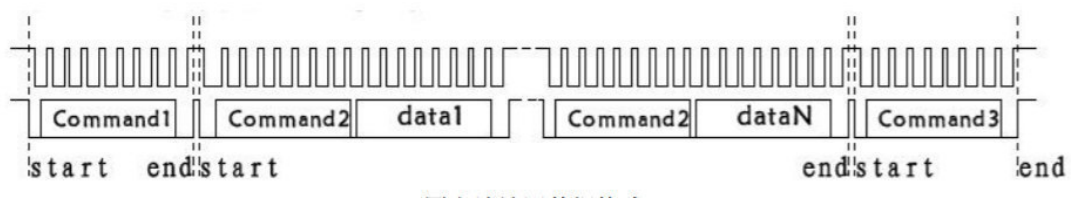

Fixed address write data format

Command1: Setting data

Command2: Setting address

Data1~N: Transfer display data

Command3: Control display

Data instruction

Instructions are used to set the display mode and the status of the LED driver. The first byte entered by DIN is used as an instruction after the instruction START is valid. After decoding, the B7 and B6 bits are taken to distinguish different instructions.

B7	B6	Introduction
0	1	Data command setting
1	0	Display control command setting
1	1	Address command setting

If END is valid when an instruction or data transfers, the serial communication is initialized and the instruction or data being transferred is invalid (the previous transmitted instruction or data remains valid).

Data command settings:

B7	B6	B5	B4	B3	B2	B1	B0	Description
0	1	Irrelevant item, fill in 0			0	Irrelevant item, fill in 0		Address
0	1				1			Address automatically added 1
0	1		0					Fixed address
0	1		1					Universal mode
								Test mode

Address command setting

B7	B6	B5	B4	B3	B2	B1	B0	Display address
1	1	Irrelevant item, fill in 0		0	0	0	0	00H
1	1			0	0	0	1	01H
1	1			0	0	1	0	02H
1	1			0	0	1	1	03H
1	1			0	1	0	0	04H
1	1			0	1	0	1	05H
1	1			0	1	1	0	06H
1	1			0	1	1	1	07H
1	1			1	0	0	0	08H
1	1			1	0	0	1	09H
1	1			1	0	1	0	0AH
1	1			1	0	1	1	0BH
1	1			1	1	0	0	0CH
1	1			1	1	0	1	0DH
1	1			1	1	1	0	0EH
1	1			1	1	1	1	0FH

Display address command settings

At power-on, the address is set to 00H by default.

The correspondent relationship between display data and chip pins and display addresses is shown in the following table:

SEG8	SEG7	SEG6	SEG5	SEG4	SEG3	SEG2	SEG1
B7	B6	B5	B4	B3	B2	B1	B0
							GRID1
							GRID2
							GRID3
							GRID4
							GRID5
							GRID6
							GRID7
							GRID8
							GRID9
							GRID10
							GRID11
							GRID12
							GRID13
							GRID14
							GRID15
							GRID16

The correspondent relationship between display data, address, and chip pins

Display control

MSB				LSB				Fuction	Description
B7	B6	B5	B4	B3	B2	B1	B0		
1	0	Irrelev ant item, fill in 0		1	0	0	0	Brightness setting	Set pulse width 1/16
1	0		1	0	0	1	Set pulse width 2/16		
1	0		1	0	1	0	Set pulse width 4/16		
1	0		1	0	1	1	Set pulse width 10/16		
1	0		1	1	0	0	Set pulse width 11/16		
1	0		1	1	0	1	Set pulse width 12/16		
1	0		1	1	1	0	Set pulse width 13/16		
1	0		1	1	1	1	Set pulse width 14/16		
1	0			0	X	X	X	Display switch setting	Display on
1	0			1	X	X	X		Display off

Display mode control instruction

Display cycle

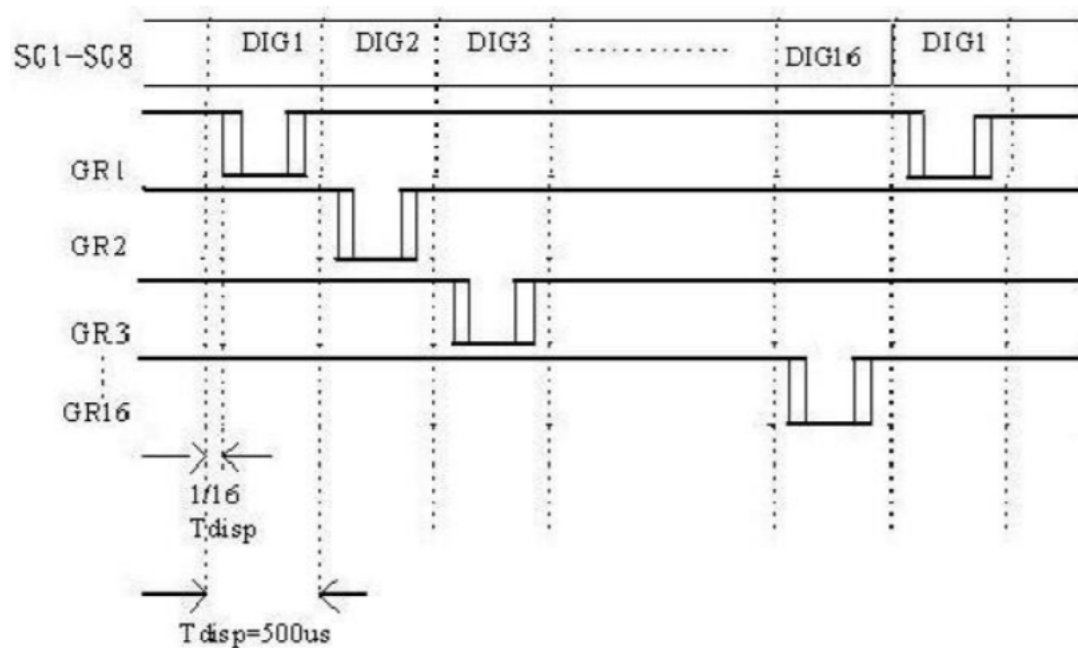

Typical application diagram and instructions

The digital tube connected in the circuit diagram is a common cathode digital tube:

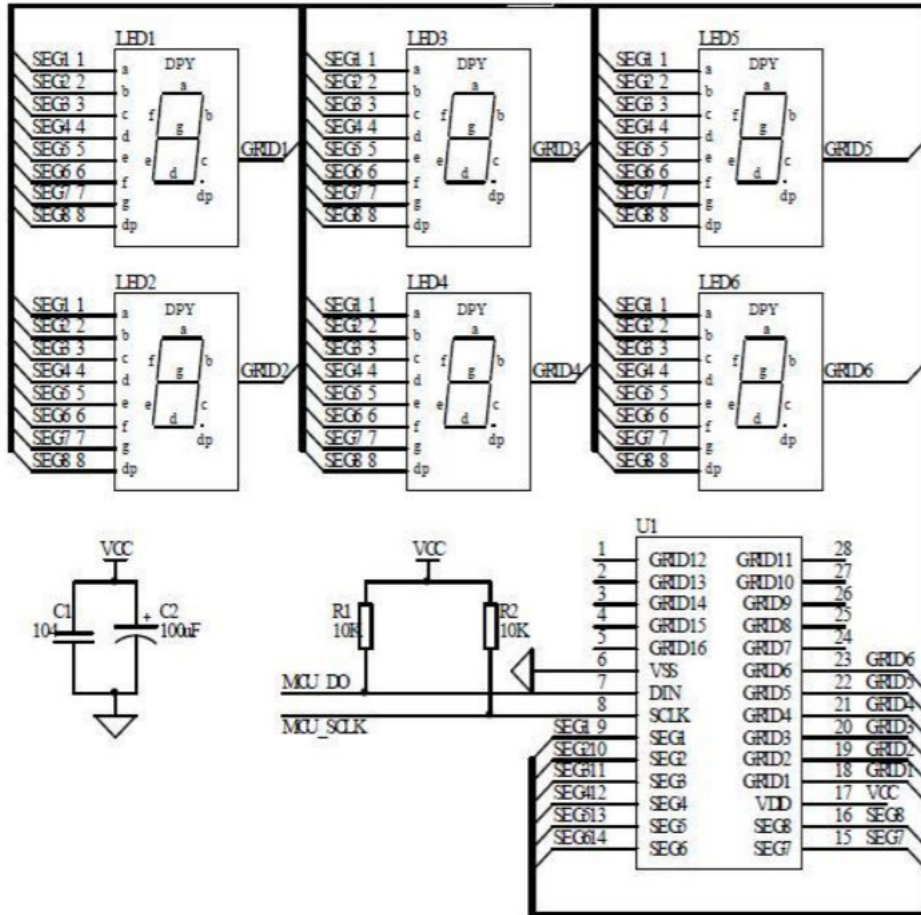

Package size and outline drawing

SOP28 outline drawing and package size

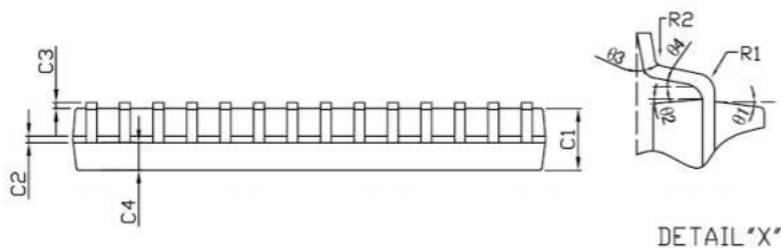
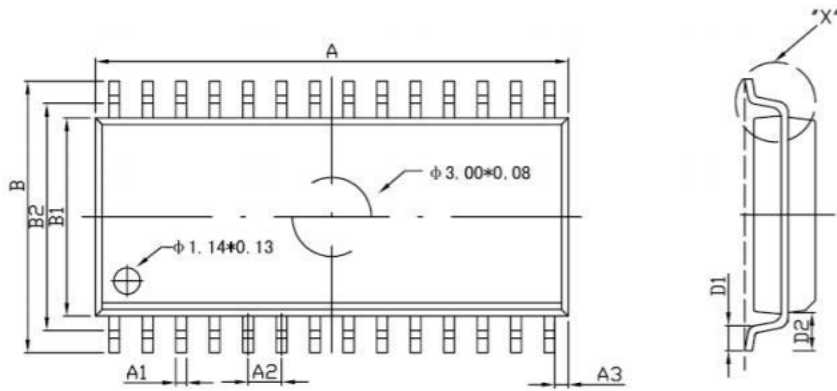

DETAIL "X"

Label	Minimum	Maximum	Label	Minimum	Maximum
A	17.83	18.03	C4	1.043TYP	
A1	0.4064TYP		D1	0.70	0.90
A2	1.27TYP		D2	1.395TYP	
A3	0.51TYP		R1	0.508TYP	
B	9.90	10.50	R2	0.508TYP	
B1	7.42	7.62	$\theta 1$	7° TYP	
B2	8.9TYP		$\theta 2$	5° TYP	
C1	2.24	2.44	$\theta 3$	4° TYP	
C2	0.204	0.33	$\theta 4$	10° TYP	
C3	0.10	0.25			

Declarations and Precautions:

The name and content of toxic and hazardous substances or elements in the product

Component	Toxic or harmful substances or elements						
	Lead (Pb)	Mercury (Hg)	Cadmium (Cd)	sixth-order chromium (Cr(VI))		Polybrominated biphenyl (PBBs)	Polybrominated biphenyl Ethers (PBDEs)
Lead Frame	o	o	o	o	o		o
Sealing Gum	o	o	o	o	o		o
Chip	o	o	o	o	o		o
Inner Lead	o	o	o	o	o		o
Loading Glue	o	o	o	o	o		o
Description	<p>o: indicates that the content of the toxic or hazardous substance or element is less than the SJ/T11363-2006 standard detection limit.</p> <p>×: indicates that the content of the toxic or hazardous substance or element exceeds the limit of SJ/T11363-2006 standard requirements.</p>						

Attention

It is recommended to read this information carefully before using this product;

The information in this document is subject to change without notice.

This information is only for reference and we don't assume any loss arising therefrom;

The company does not assume any responsibility for infringement of third party patents or other rights when in use.