

PROJECT A - HEART BULB CRAFT CARD WITH WHITE LED

1 Material

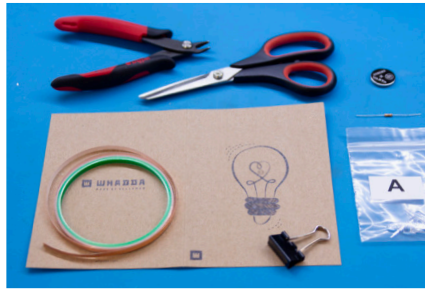

- 1x LED (A)
- 1x resistor (brown, black, brown)
- 1x 3V battery
- copper tape
- paper clip
- tweezers or needle
- scissors

More info online: www.whadda.com/product/wsedu07/VAL

2

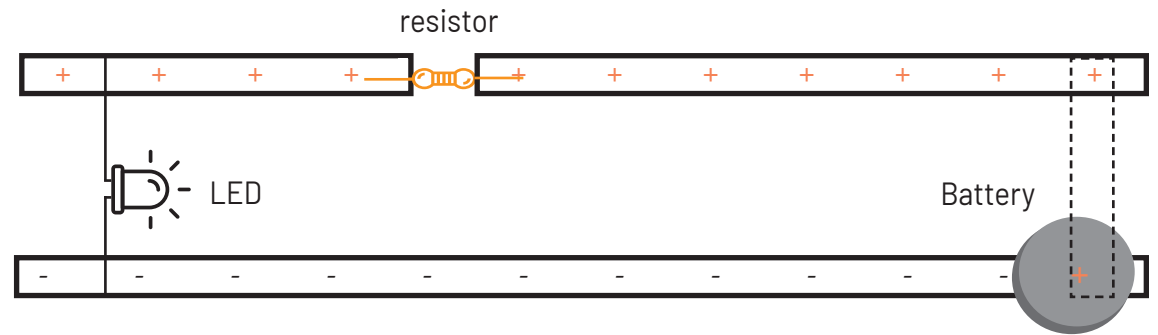

3 Copper tape circuit

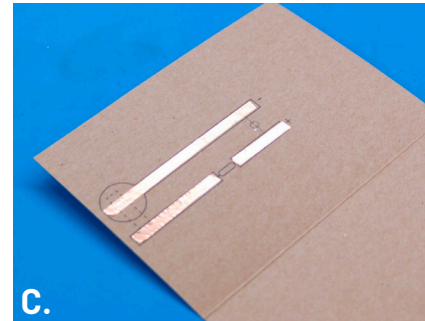
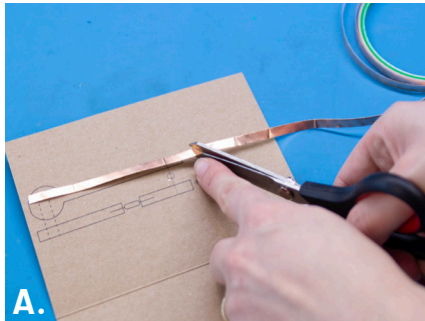

4 Resistor

brown, black, brown - bruin, zwart, bruin - marron, noir, marron - braun, schwarz, braun - marrón, negro, marrón

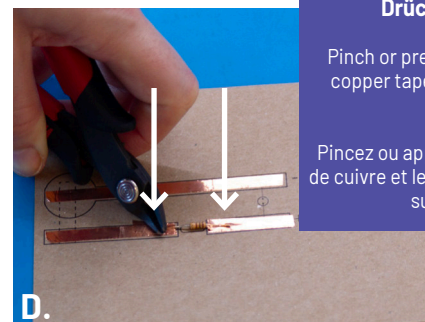
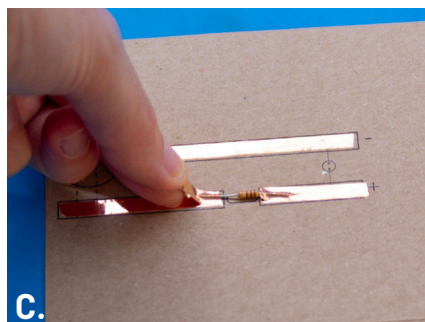
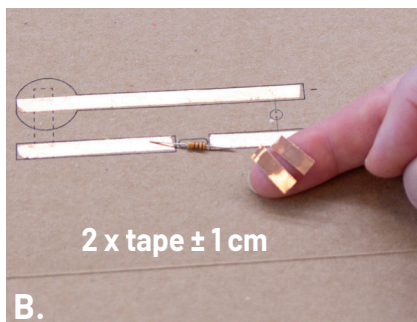
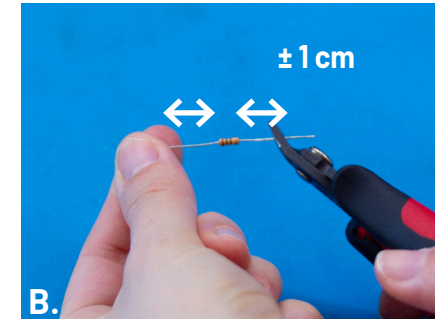

Press / duw / presse / Drücken Sie / prensa

Pinch or press the lead down into the copper tape and cardboard for extra connection!

Pincez ou appuyez le lead dans le ruban de cuivre et le carton pour une connexion supplémentaire !

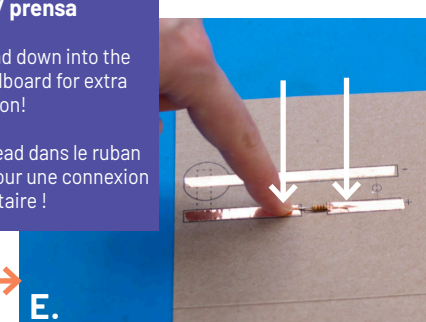

5 LED

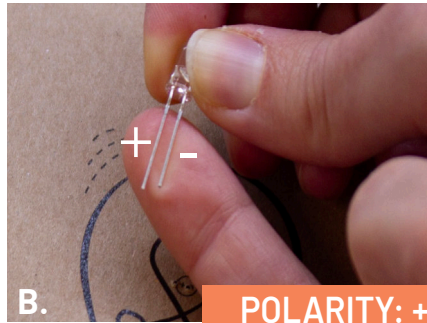
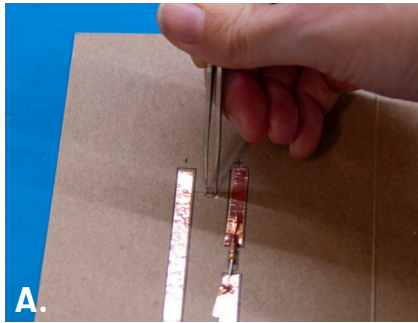

POLARITY: + & -

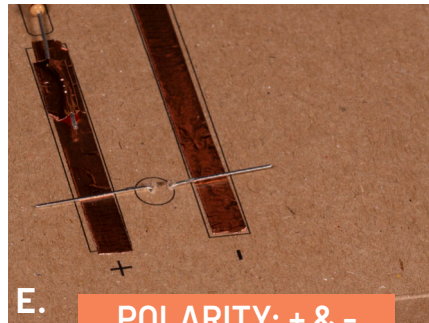
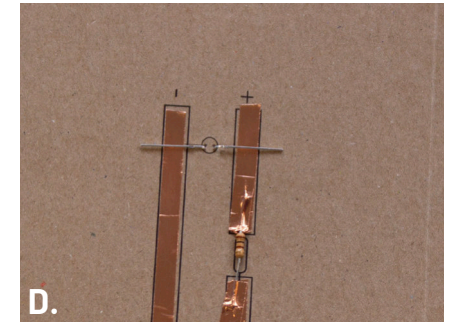
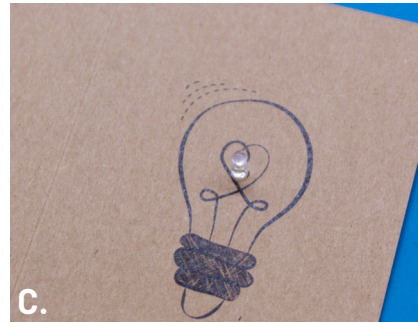

POLARITY: + & -

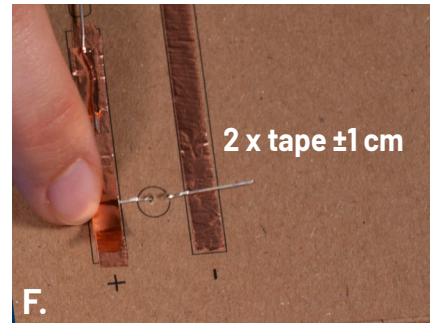

2 x tape ±1 cm

Press / duw / presse /
Drücken Sie / prensa

Pinch or press the lead down into the copper tape and cardboard for extra connection!

Pincez ou appuyez le lead dans le ruban de cuivre et le carton pour une connexion supplémentaire !

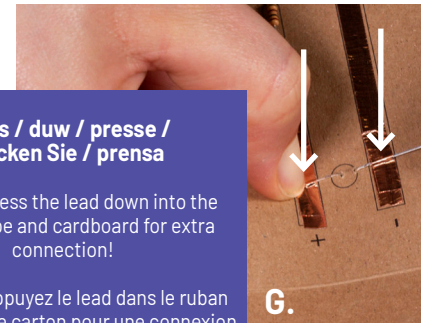

G.

5 Battery



POLARITY: + & -

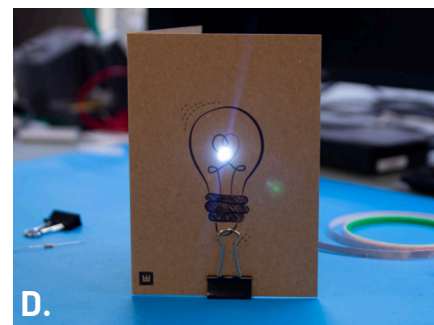
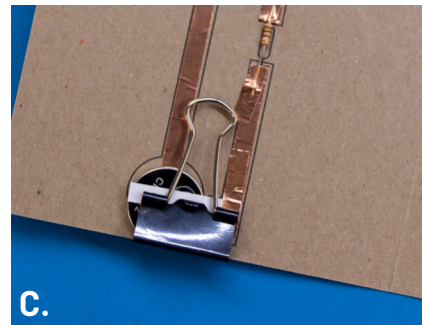

PROJECT B - HEART BALLOON CRAFT CARD WITH TWO CANDLE FLICKERING LEDS

1 Material

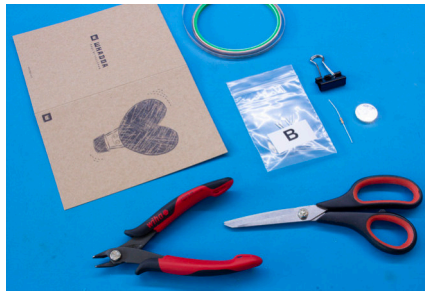

- 2 x LED (B)
- 1 x resistor (orange, orange, black)
- 1 x 3V battery
- copper tape
- paper clip
- tweezers or needle
- scissors

More info online: www.whadda.com/product/wsedu07/VAL

2

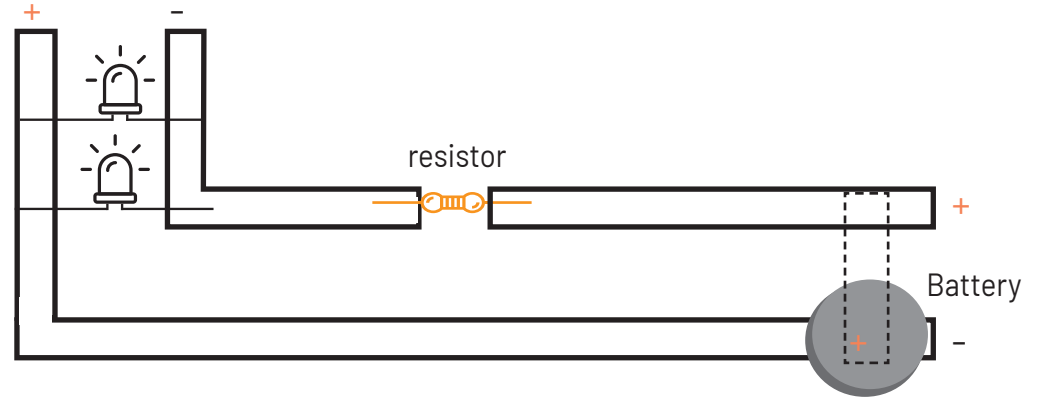

3 Copper tape circuit

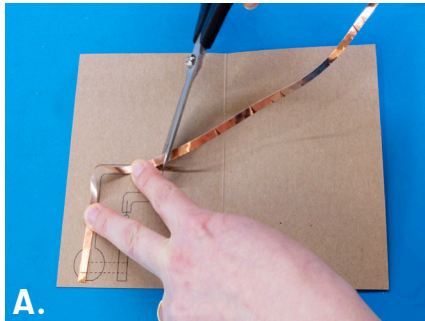

BEND, DON'T BREAK!
 BUIGEN, NIET BREKEN!
 PLIEZ, NE CASSEZ PAS!
 BIEGEN, NICHT BRECHEN!
 DOBLAR, NO ROMPER!

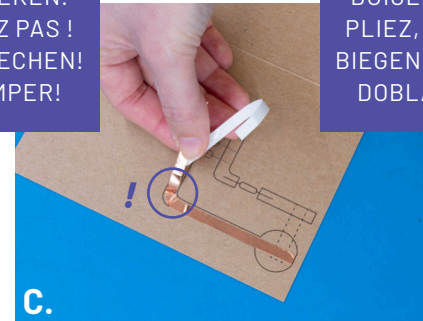

BEND, DON'T BREAK!
 BUIGEN, NIET BREKEN!
 PLIEZ, NE CASSEZ PAS!
 BIEGEN, NICHT BRECHEN!
 DOBLAR, NO ROMPER!

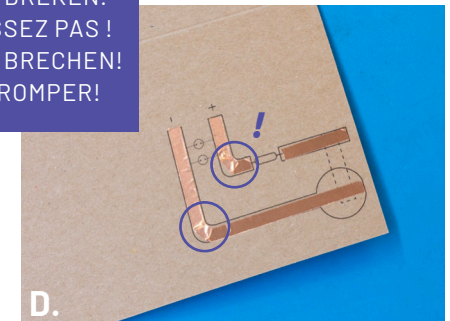

4 Resistor orange, orange, black - oranje, oranje, zwart - orange, orange, noir - orange, orange, schwarz - naranja, naranja, negro

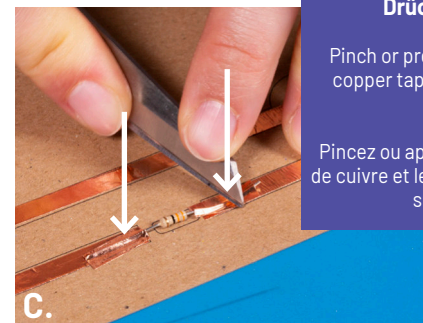
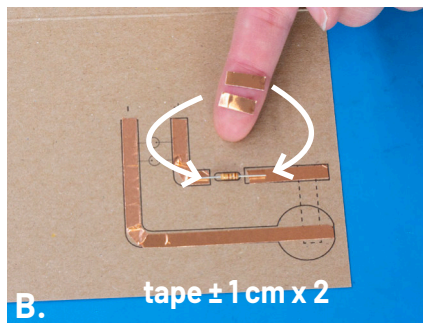
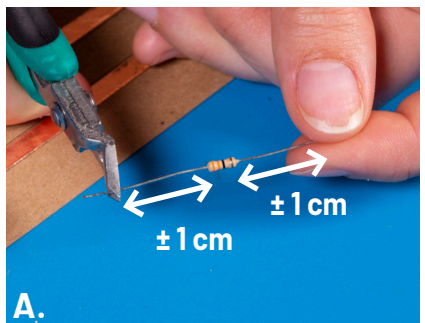

Press / duw / presse /
 Drücken Sie / prensa

Pinch or press the lead down into the copper tape and cardboard for extra connection!

Pincez ou appuyez le lead dans le ruban de cuivre et le carton pour une connexion supplémentaire !

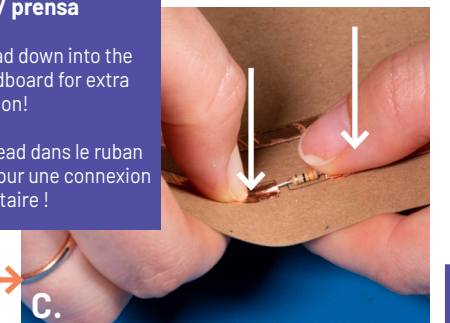

5 LEDs x 2

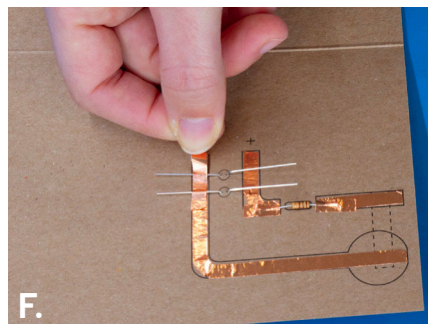
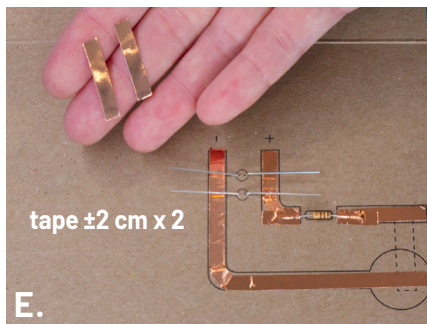
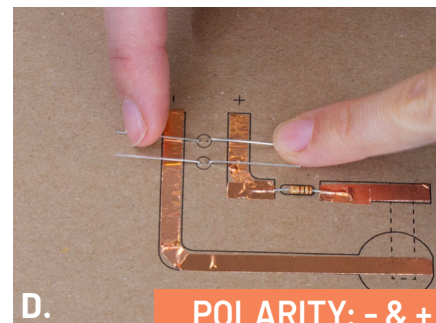
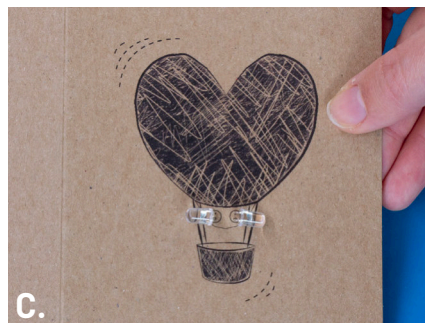
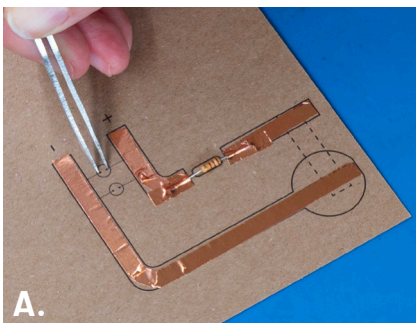

**Press / duw / presse /
Drücken Sie / prensa**

Pinch or press the lead down into the copper tape and cardboard for extra connection!

Pincez ou appuyez le lead dans le ruban de cuivre et le carton pour une connexion supplémentaire !

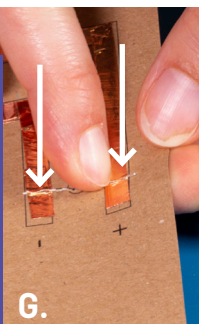

=

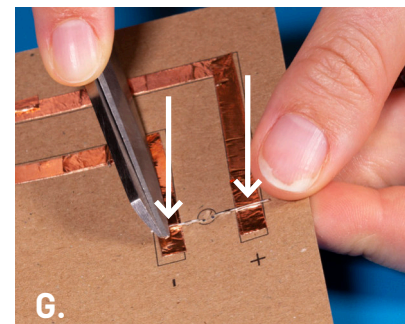

5 Battery

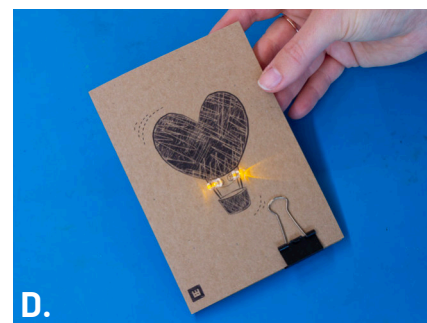
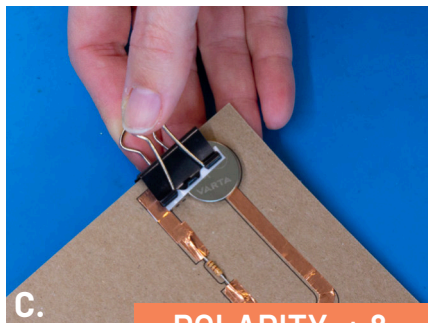
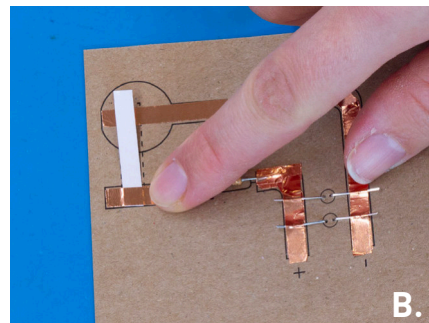
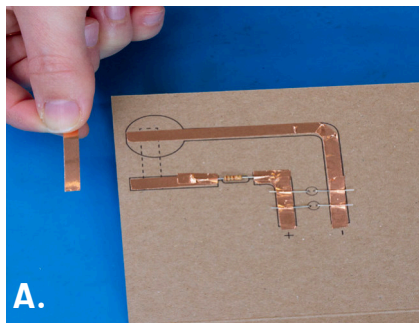

PROJECT C - HEART CRAFT CUBE WITH THREE RGB FLICKERING LEDs

1 Material



- 3 x LED (C)
- 1 x resistor (brown, orange, orange)
- 1 x 3V battery
- copper tape
- 10 x pins
- glue & paper
- scissors or pliers

More info online: www.whadda.com/product/wsedu07/VAL

2

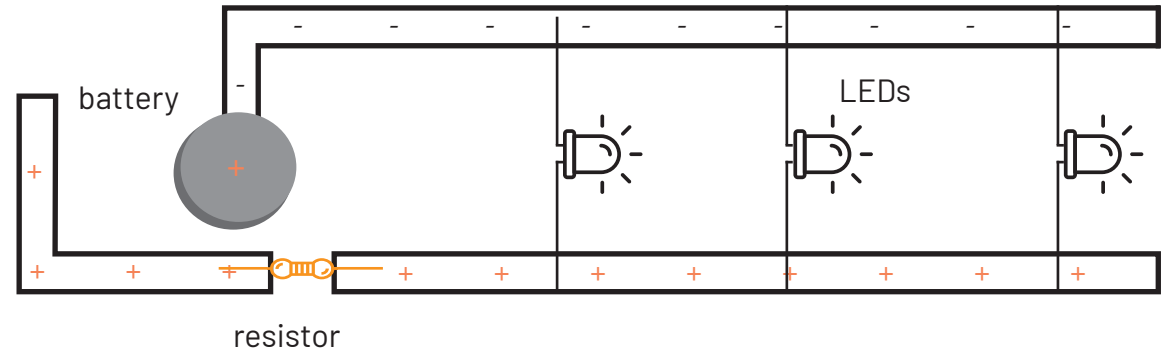

3 Copper tape circuit



BEND, DON'T BREAK!
 BUIGEN, NIET BREKEN!
 PLIEZ, NE CASSEZ PAS!
 BIEGEN, NICHT BRECHEN!
 DOBLAR, NO ROMPER!



BEND, DON'T BREAK!
 BUIGEN, NIET BREKEN!
 PLIEZ, NE CASSEZ PAS!
 BIEGEN, NICHT BRECHEN!
 DOBLAR, NO ROMPER!



4 Resistor orange, orange, black - oranje, oranje, zwart - orange, orange, noir - orange, orange, schwarz - naranja, naranja, negro

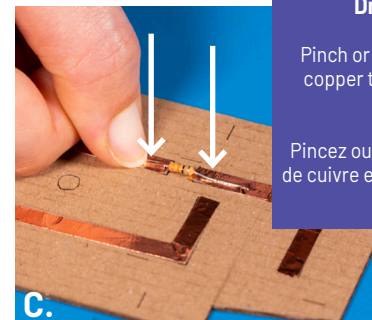
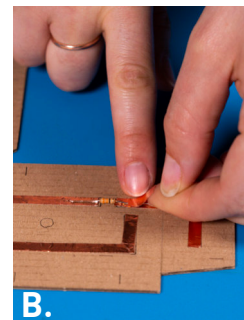
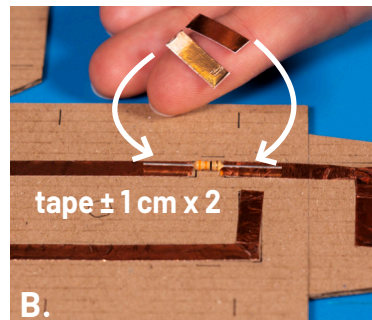
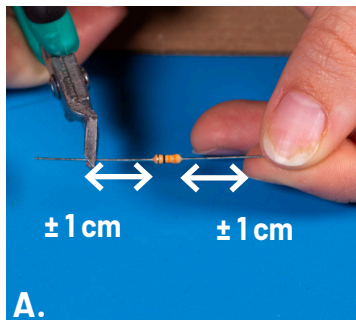

Press / duw / presse /
 Drücken Sie / prensa

Pinch or press the lead down into the copper tape and cardboard for extra connection!

Pincez ou appuyez le lead dans le ruban de cuivre et le carton pour une connexion supplémentaire !



5 LEDs x 3

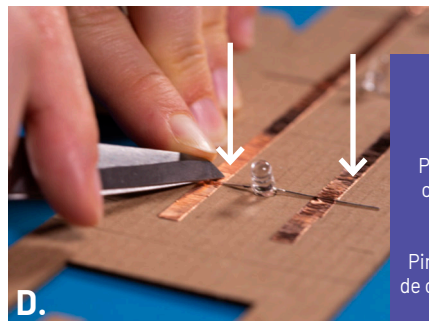
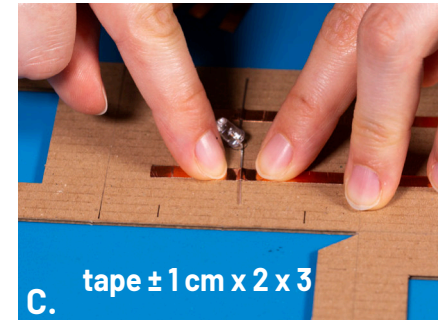
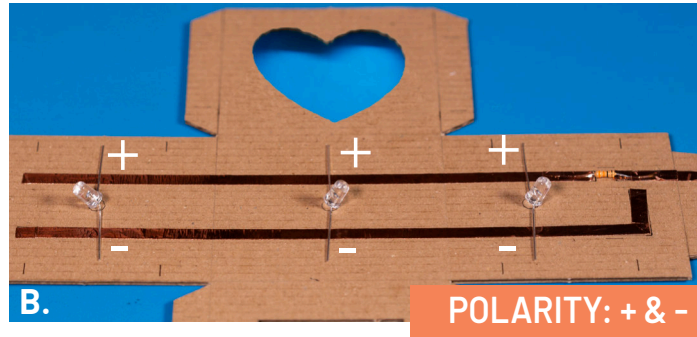
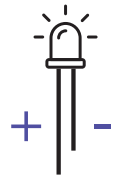
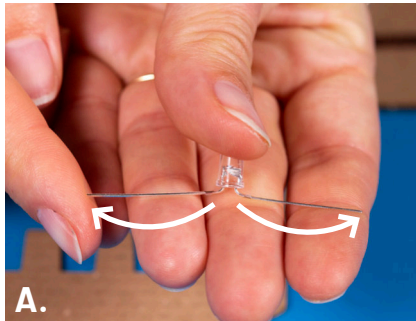

Press / duw / presse / Drücken Sie / prensa
 Pinch or press the lead down into the copper tape and cardboard for extra connection!
 Pincez ou appuyez le lead dans le ruban de cuivre et le carton pour une connexion supplémentaire !



8 Cube

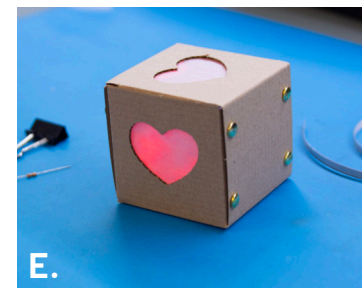
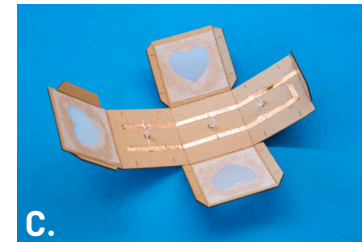
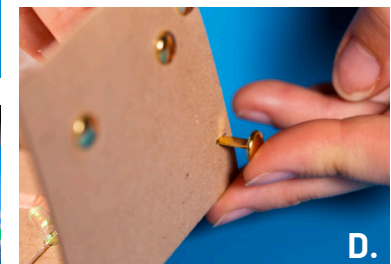
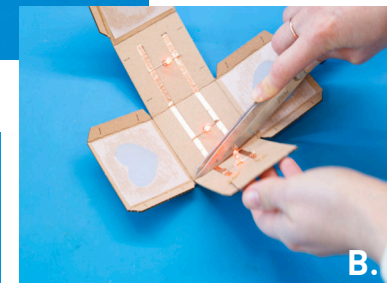
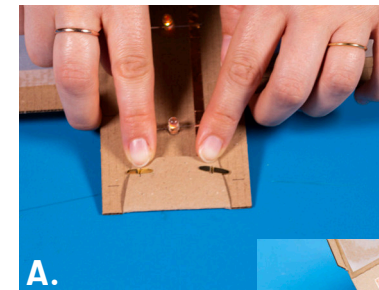

6 Battery

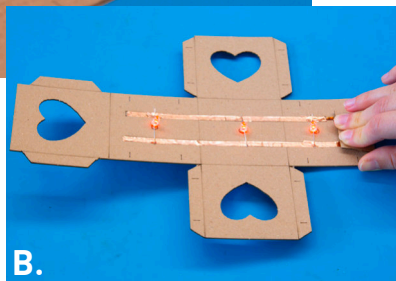
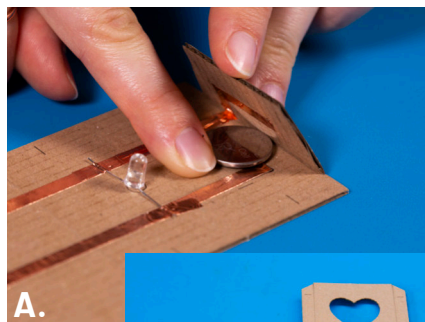

7 Windows

