

PROJECT B - HEART BALLOON CRAFT CARD WITH TWO CANDLE FLICKERING LEDS

1 Material

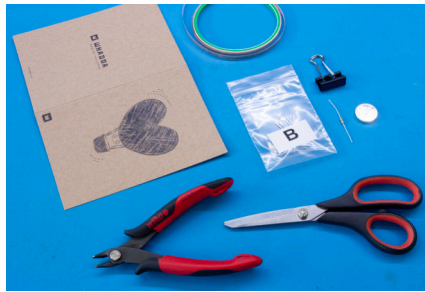

- 2 x LED (B)
- 1 x resistor (orange, orange, black)
- 1 x 3V battery
- copper tape
- paper clip
- tweezers or needle
- scissors

More info online: www.whadda.com/product/wsedu07/VAL

2

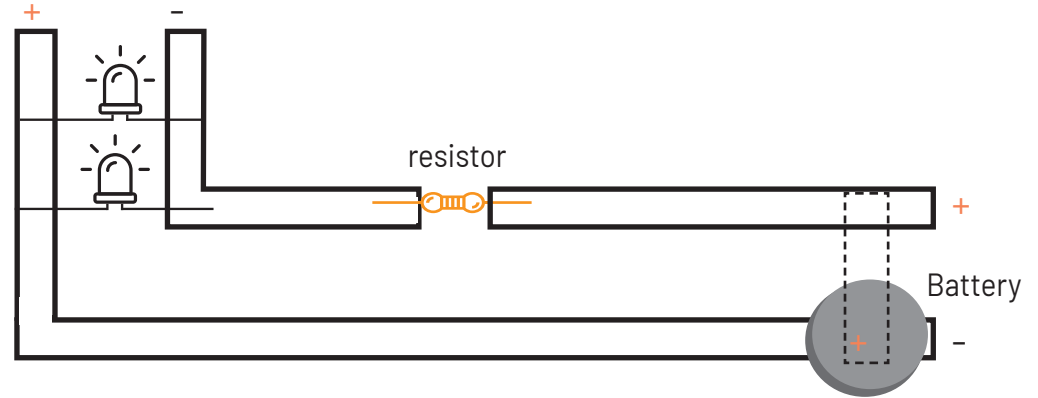

3 Copper tape circuit

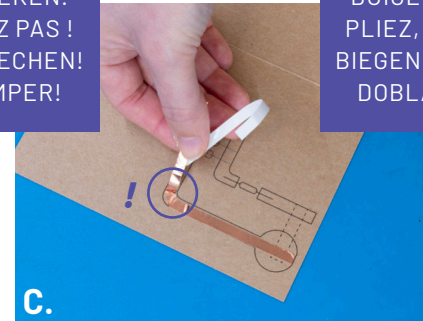
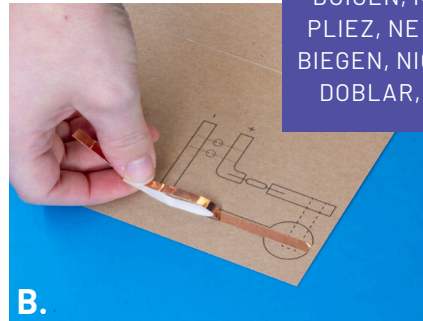
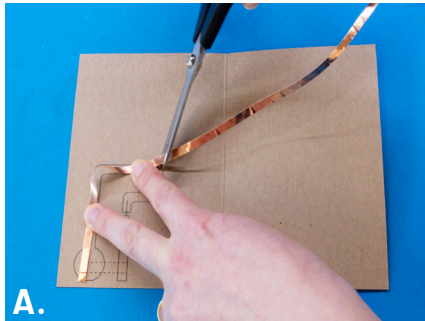

4 Resistor orange, orange, black - oranje, oranje, zwart - orange, orange, noir - orange, orange, schwarz - naranja, naranja, negro

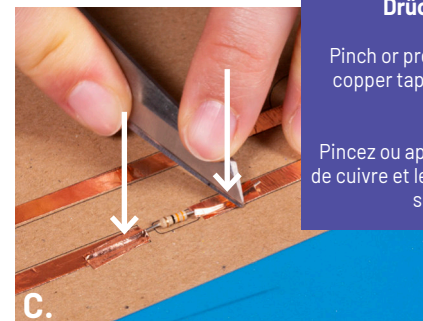
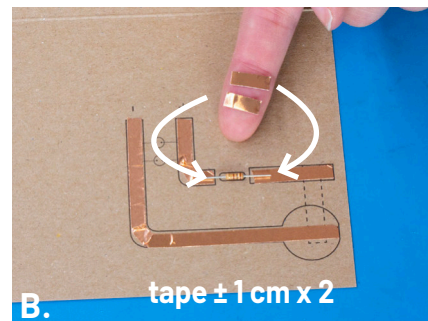
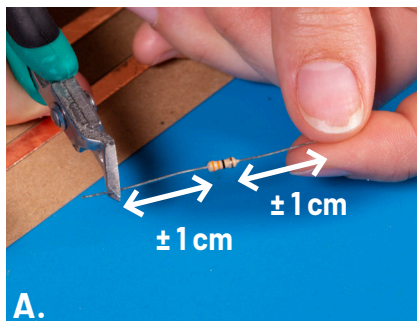

5 LEDs x 2

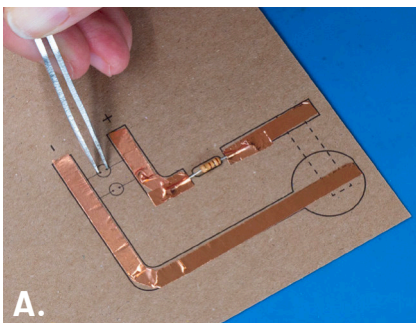

A.



B.

POLARITY: + & -

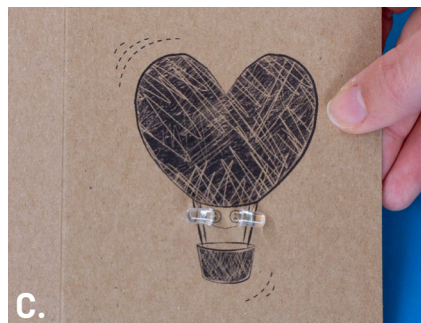
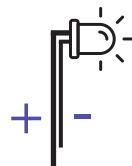

C.

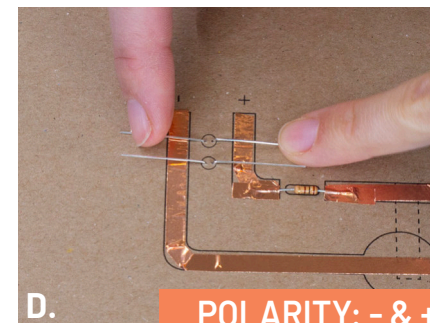

D.

POLARITY: - & +

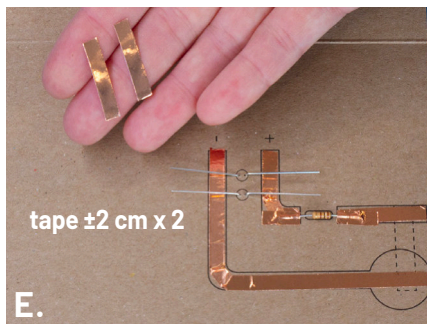

E.

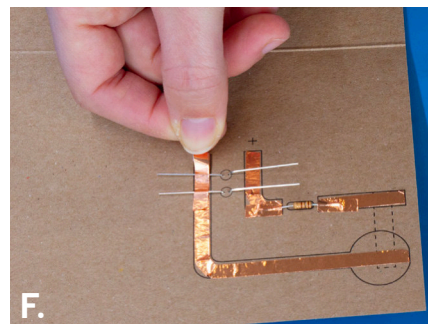

F.

Press / duw / presse / Drücken Sie / prensa

Pinch or press the lead down into the copper tape and cardboard for extra connection!

Pincez ou appuyez le lead dans le ruban de cuivre et le carton pour une connexion supplémentaire !

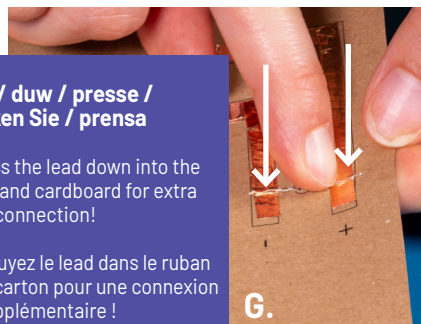

G.

=

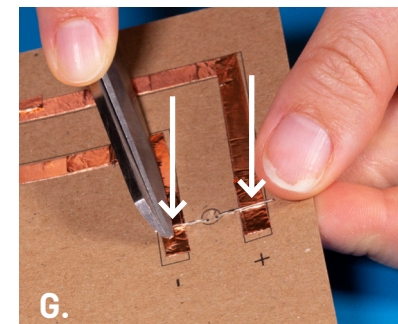

G.

5 Battery

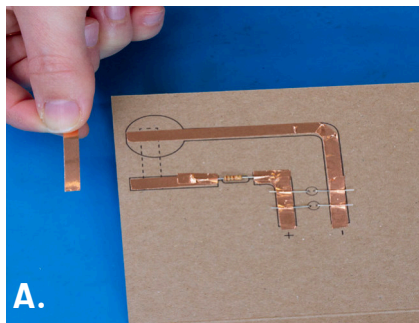

A.

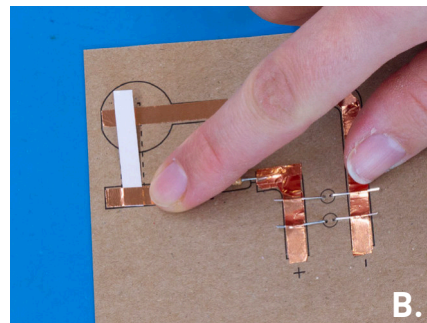

B.

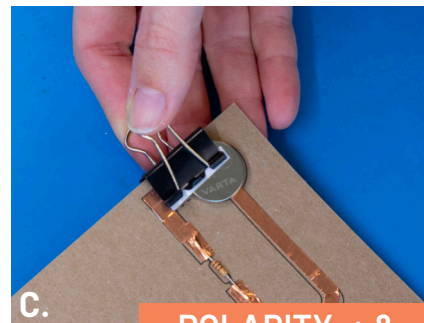

C.

POLARITY: + & -

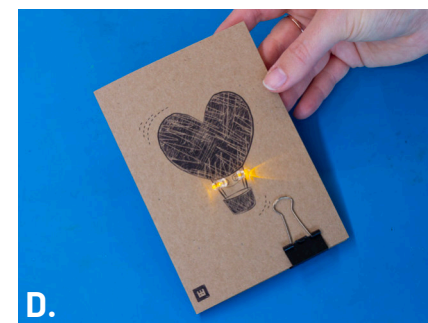

D.