

1

Resistor - Weerstand - Résistance - Widerstand - Resistencia - Motstånd - Vastus - Resistenze

◇ R1... R4: 470

(Yellow, Purple, Brown) - (Geel, Paars, Bruin) - (Jaune, Violet, Brun) - (Gelb, Violet, Braun) - (Gul, Lila, Brun) - (Keltainen, Purppura, Ruskea) - (Amarillo, Morado, Marrón) - (Amarelo, Violeta, Castanho) - (Giallo, Viola, Marrone)

(Yellow, Purple, Red) - (Geel, Paars, Rood) - (Jaune, Violet, Rouge) - (Gelb, Violet, Rot) - (Gul, Lila, Röd) - (Keltainen, Purppura, Punainen) - (Amarillo, Morado, Rojo) - (Amarelo, Violeta, Encarnado) - (Giallo, Viola, Rosso)

(Yellow, Purple, Black) - (Geel, Paars, Zwart) - (Jaune, Violet, Noir) - (Gelb, Violet, Schwarz) - (Gul, Lila, Svart) - (Keltainen, Purppura, Musta) - (Amarillo, Morado, Negro) - (Amarelo, Violeta, Preto) - (Giallo, Viola, Nero)

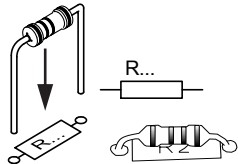

2

Diode

Watch the polarity!
Att. la polarité!

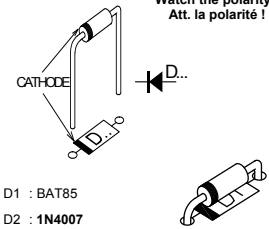

◇ D1 : BAT85
◇ D2 : 1N4007

3

Push buttons

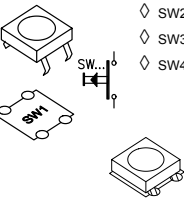

◇ SW1
◇ SW2
◇ SW3
◇ SW4

4

IC socket

WATCH THE POSITION
OF THE NOTCH!
ATTENTION A LA POSITION DE
L'ENCOCHE!

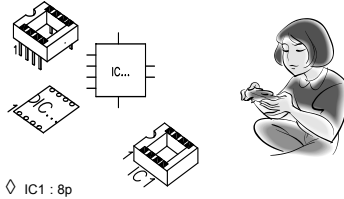

◇ IC1 : 8p

9

IC
WATCH THE POSITION
OF THE NOTCH!
ATTENTION A LA POSITION DE
L'ENCOCHE!

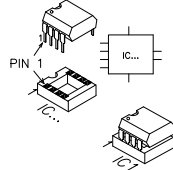

◇ IC1 : PIC12C508A

10

Battery lips

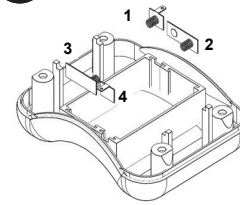

1

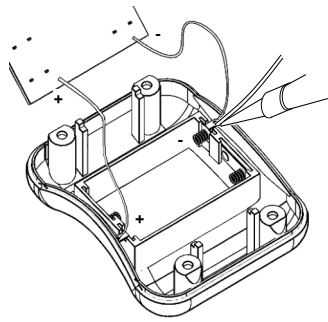
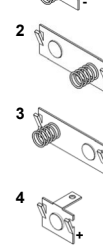

11

Batteries

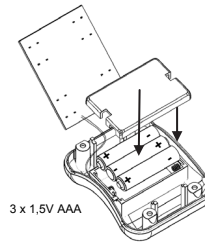

13

Diagram

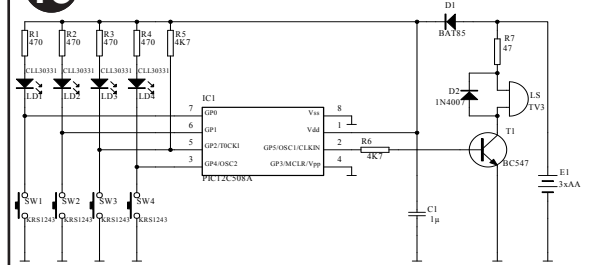

12

Assembly

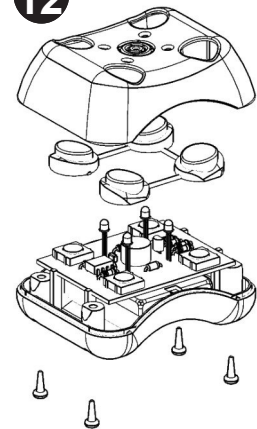

START:

1

2



LEVEL 1
LEVEL 2= 10
LEVEL 3= 15



LEVEL 4



20