

Soldering - Solderen - Soudage - Lötten - Soldadura - Lötning - Juottaminen - Saldatura - Solda

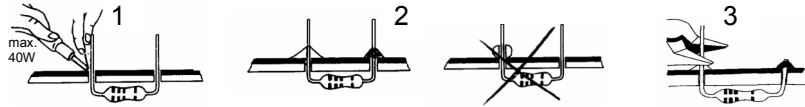

START

1

Resistor - Weerstand - Résistance - Widerstand - Resistencia - Motstand - Vastus - Resistenze

◇ R1 ... R4 : 10K

(Brown, Black, Orange) - (Bruin, Zwart, Oranje) - (Brun, noir, Orange) - (Braun, Schwarz, Orange) - (Brun, Svart, Orange) - (Ruskea, Musta, Oranssi) - (Marrón, Negro, Naranjado) - (Castanho, Preto, Laranja) - (Marrone, Nero, Aranciato)

◇ R5 ... R9 : 100K

(Brown, Black, Yellow) - (Bruin, zwart, Geel) - (Brun, Noir, Jaune) - (Braun, Schwarz, Gelb) - (Brun, Svart, Gul) - (Ruskea, Musta, Keltainen) - (Marrón, Negro, Amarillo) - (Castanho, Preto, Amarelo) - (Marrone, Nero, Giallo)

◇ R10 ... R12: 1K

(Brown, Black, Red) - (Bruin, Zwart, Rood) - (Brun, Noir, Rouge) - (Braun, Schwarz, Rot) - (Brun, Svart, Rött) - (Ruskea, Musta, Punainen) - (Marrón, Negro, Rojo) - (Castanho, Preto, Encarnado) - (Marrone, Nero, Rosso)

◇ R13 : 1

(Brown, Black, Gold) - (Bruin, Zwart, Goud) - (Brun, Noir, Or) - (Braun, Schwarz, Gold) - (Brun, Svart, Guld) - (Ruskea, Musta, Kulta) - (Marrón, Negro, Oro) - (Castanho, Preto, Dourado) - (Marrone, Nero, Oro) - (Brun, Sort, Guld)

◇ R14 : 68K

(Blue, Grey, Orange) - (Blauw, Grijs, Oranje) - (Bleu, Gris, Orange) - (Blau, Grau, Orange) - (Bli, Grí, Orange) - (Sininen, Harmaa, Oranssi) - (Azul, Gris, Naranjado) - (Azul, Cinzento, Laranja) - (Blu, Grigio, Aranciato) - (Bli, Grí, ...)

◇ R15 : 270K

(Red, Purple, Yellow) - (Rood, Paars, Geel) - (Rouge, Violet, Gelb) - (Rot, Violet, Gul) - (Rött, Lila, Gul) - (Punainen, Purppura, Keltainen) - (Rojo, Morado, Amarillo) - (Encarnado, Violeta, Amarelo) - (Rosso, Viola, Giallo) - (Sort, Violet, Gul)

◇ R16, R17 : 470

(Yellow, Purple, Brown) - (Geel, Paars, Bruin) - (Jaune, Violet, Brun) - (Gelb, Violet, Braun) - (Gul, Lila, Brun) - (Keltainen, Purppura, Ruskea) - (Amarillo, Morado, Marrón) - (Amarelo, Violeta, Castanho) - (Giallo, Viola, Marrone) - (Gul, Violet, Brun)

◇ R18 : 0

(Black) - (zwart) - (noir) - (Schwarz) - (Svart) - (Musta) - (Negro) - (Preto) - (Nero)

2

ZENER DIODES

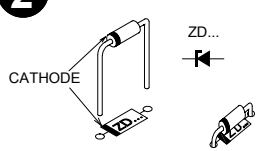

◇ ZD1 : 4V7

Watch the polarity !  
Attention ç la polarité !

3

DIODE

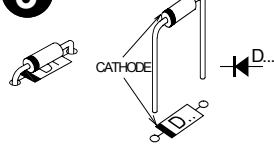

◇ D1 : 1N4007

◇ D2 ... D4 : 1N4148

Watch the polarity !  
Att. ç la polarité !

4

CAPACITORS

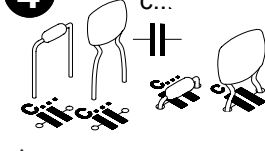

◇ C2 ... C7 : 100nF (104)

◇ C8 : 3n3 (332)

◇ C9 : 22nF (223)

5

IC SOCKET

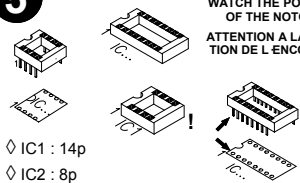

WATCH THE POSITION OF THE NOTCH !  
ATTENTION A LA POSITION DE L'ENCOCHE !

◇ IC1 : 14p

◇ IC2 : 8p

6

SWITCH

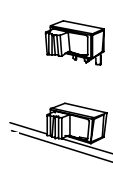

◇ SW1

◇ SW2

7

TRANSISTORS

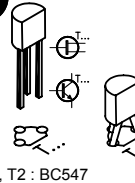

◇ T1, T2 : BC547

8

VOLTAGE REGULATORS

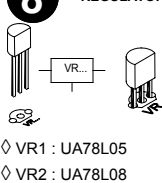

◇ VR1 : UA78L05

◇ VR2 : UA78L08

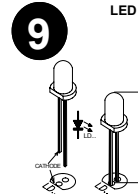

LED

Watch the polarity !  
Attention ç la polarité !

◇ LD1 : CLAP

◇ LD2 : RELAY ON

10

ELECTROLYTIC CAPACITORS

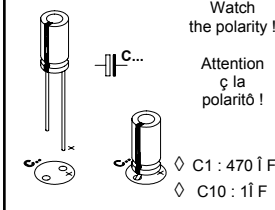

Watch the polarity !  
Attention ç la polarité !

◇ C1 : 470µF

◇ C10 : 1µF

11

CONNECTORS

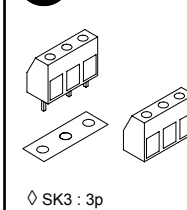

◇ SK3 : 3p

12

POWER JACK

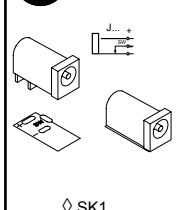

◇ SK1

13

MICROPHONE

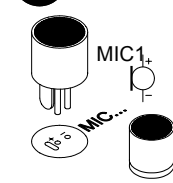

◇ Mic 1

14

RELAY

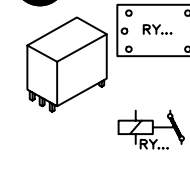

◇ RY1 : VR15M121C

15

IC

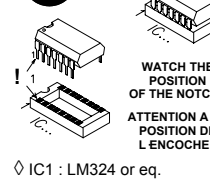

WATCH THE POSITION OF THE NOTCH !  
ATTENTION A LA POSITION DE L'ENCOCHE !

◇ IC1 : LM324 or eq.

◇ IC2 : PIC 12C508A

16

PCB TABS

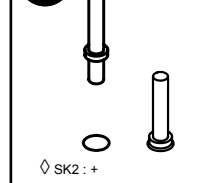

◇ SK2 : +

◇ SK2 : -

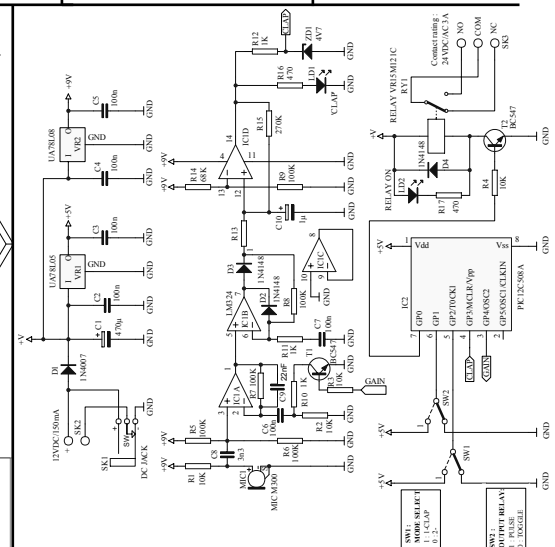
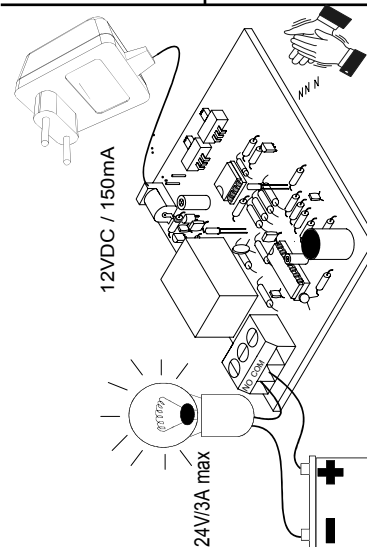

SCHEMATIC DIAGRAM