

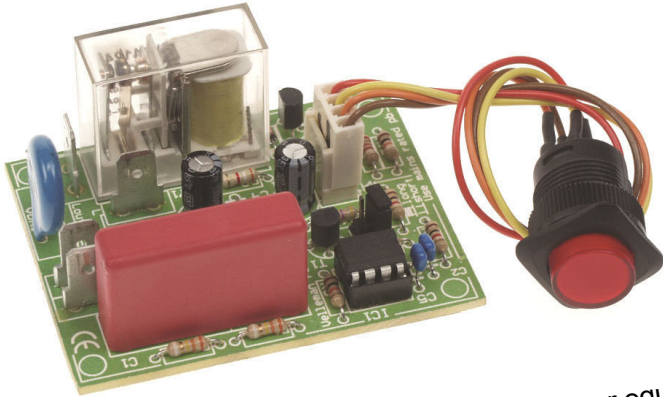

## POWER SAVER / TIMER



***K8075***

Turns off your equipment after a preset time, it helps you save money and it increases safety



**VELLEMAN NV**  
**Legen Heirweg 33**  
**9890 Gavere**  
**Belgium Europe**  
**[www.velleman.be](http://www.velleman.be)**  
**[www.velleman-kit.com](http://www.velleman-kit.com)**

The power saver turns off your equipment after a preset time. It helps you save money and it increases safety.

### FEATURES:

- Single button operation with LED mode indicator
  - *continuous* : 24h turn-off timer
  - *slow flashing* : 4h or 8h turn-off timer
  - *fast flashing* : 1h or 2h turn-off timer
  - *dim* : idle
- Choose short or long-running timers (one-time jumper setting)
- 10A suppressed relay output
- Easy to add to existing equipment

**Applications:** automatically turn off heating, cooling, lighting, entertainment systems, fans, pumps, sprinklers, etc...

### SPECIFICATIONS:

- Available timers: 1h / 2h / 4h / 8h / 24h
- Relay output: 10A / 240VAC max
- Power supply: 100 - 240VAC
- Dimensions: 65 x 50 x 26mm

### 1. Assembly (Skipping this can lead to troubles !)

Ok, so we have your attention. These hints will help you to make this project successful. Read them carefully.

#### 1.1 Make sure you have the right tools:

- A good quality soldering iron (25-40W) with a small tip.
- Wipe it often on a wet sponge or cloth, to keep it clean; then apply solder to the tip, to give it a wet look. This is called 'thinning' and will protect the tip, and enables you to make good connections. When solder rolls off the tip, it needs cleaning.
- Thin raisin-core solder. Do not use any flux or grease.
- A diagonal cutter to trim excess wires. To avoid injury when cutting excess leads, hold the lead so they cannot fly towards the eyes.
- Needle nose pliers, for bending leads, or to hold components in place.
- Small blade and Phillips screwdrivers. A basic range is fine.

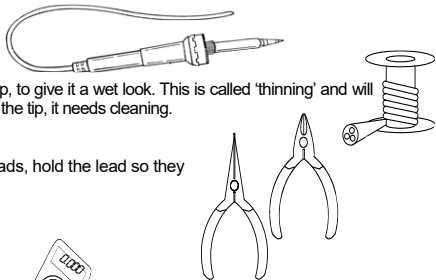

**For some projects, a basic multi-meter is required, or might be handy**



#### 1.2 Assembly Hints :

- ⇒ Make sure the skill level matches your experience, to avoid disappointments.
  - ⇒ Follow the instructions carefully. Read and understand the entire step before you perform each operation.
  - ⇒ Perform the assembly in the correct order as stated in this manual
  - ⇒ Position all parts on the PCB (Printed Circuit Board) as shown on the drawings.
  - ⇒ Values on the circuit diagram are subject to changes.
  - ⇒ Values in this assembly guide are correct\*
  - ⇒ Use the check-boxes to mark your progress.
  - ⇒ Please read the included information on safety and customer service
- \* Typographical inaccuracies excluded. Always look for possible last minute manual updates, indicated as 'NOTE' on a separate leaflet.

**1.3 Soldering Hints :**

1- Mount the component against the PCB surface and carefully solder the leads

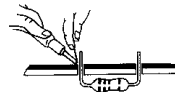

2- Make sure the solder joints are cone-shaped and shiny

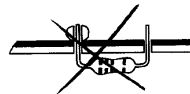

3- Trim excess leads as close as possible to the solder joint



**REMOVE THEM FROM THE TAPE ONE AT A TIME !**

**AXIAL COMPONENTS ARE TAPED IN THE  
CORRECT MOUNTING SEQUENCE !**

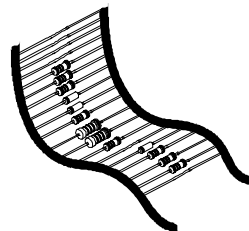

**1. Diodes. Watch the polarity !**

D1 : 1N4148

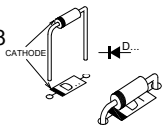
**2. Zenerdiodes. Watch the polarity !**

ZD1 : 5V/0.5W

ZD2 : 24V/1.3W

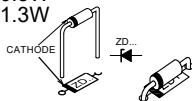
**3. Diodes. Watch the polarity !**

D2 : 1N4007

D3 : 1N4007

D4 : 1N4007

D5 : 1N4007

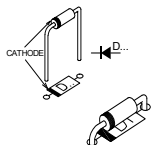
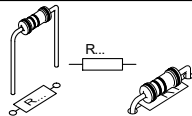
**4. Metal film resistors (1%)**

R1 : 330K (3-3-4-B-9)

R2 : 330K (3-3-4-B-9)

R3 : 220 (2-2-1-B-9)

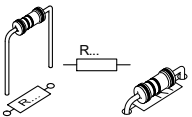
**5. Resistors**

R4 : 47K (7-7-3-B)

R5 : 1K (1-0-2-B)

R6 : 1K (1-0-2-B)

R7 : 10K (1-0-3-B)

R8 : 10K (1-0-3-B)

R9 : 10K (1-0-3-B)

R10 : 2K2 (2-2-2-B)

R11 : 6K8 (6-8-2-B)

R12 : 3K9 (3-9-2-B)

**6. IC socket. Watch the position of the notch!**

IC1 : 8p

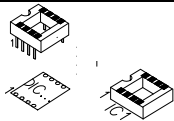
**7. Capacitors.**

C1 : 100nF (104)

C2 : 100nF (104)

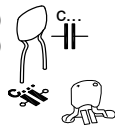

### 8. Transistors

- T1 : BC547B
- T2 : BC547B

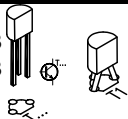

### 9. Board to wire connector

- SK6 : 4p

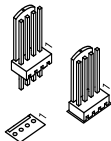

### 10. Pin header

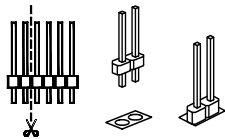

- JP1 : 2p

### 11. Shunt

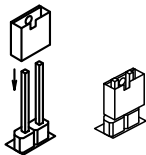

#### Choose timer :

- Mounted : 2h / 8h
- Not mounted : 1h / 4h

### 12. PCB terminals

- L AC power out
- N
- L AC power in
- N

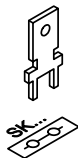

### 13. VDR

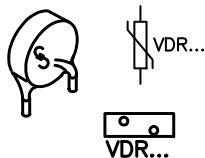

- VDR1 : VDR300

### 14. Electrolytic capacitors Watch the polarity!

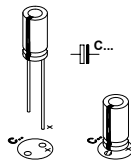

- C3 : 100 $\mu$ F / 35V
- C4 : 100 $\mu$ F / 35V

## 15. Capacitor

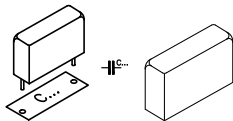

**Choose operation voltage :**

**230V :**

C5 : 0,47 $\mu$ F / 630V

**115V :**

C5 : 0,68 $\mu$ F / 400V

## 16. Relays

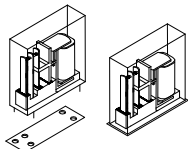

RY1 : VR10V241C  
(24DC - 10A - 1contact)

## 17. IC. Watch the position of the notch!

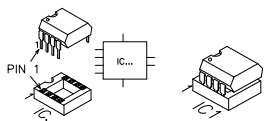

IC1 : VK8075  
(programmed PIC10F200-I/PG)



**☞ CHECK THOROUGHLY ALL THE COMPONENTS FOR MISS MOUNTING, INCLUDING SOLDERING ERRORS.**

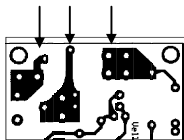

**☞ PUT AN EXTRA THICK LAYER OF SOLDER ON THESE PCB TRACKS TO IMPROVE THEIR CURRENT HANDLING CAPACITIES.**

**Fig. 1.0**



## 18. Wiring the push button

- Cut off a piece of shrinkable tube with a length equal to 2,5cm.
- Slide the shrinkable tube over the wires of the female 'board to wire'-connector (fig. 2.0)
- Solder the 4-pole female 'board to wire' connector to the push button using the figure below to check the accuracy of the connections (see figure 3.0)

 **Attention:** Always make sure to slide down the shrinking tube far enough from the soldering points!

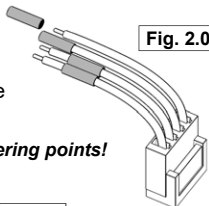
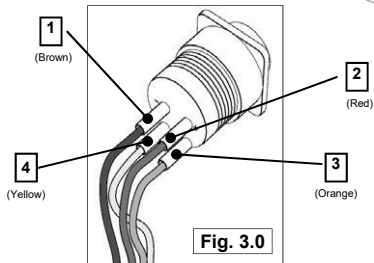
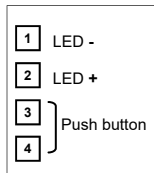
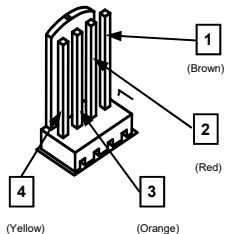
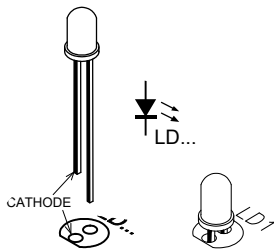

Fig. 2.0

- Slide the shrinkable tube over the soldered joints and heat them using a hair dryer or, better still, using a paint stripper.

☞ *In case you want to use a different push button, make sure it is rated for the AC-voltage.*

☞ *If you do not use the included push button, you can mount a 3mm LED on the PCB.*



**Watch the polarity !**

☞ **Do not use both simultaneously  
(LED & included push button)**

## 19. Final connection & use



**CAUTION:** All PARTS OF THE CIRCUIT CARRY DANGEROUS VOLTAGES (MAINS) ! OBSERVE ALL SAFETY REQUIREMENTS THAT MIGHT APPLY !

MOUNT THIS KIT PREFERABLY IN AN ISOLATED ENCLOSURE

- Connect your application (ex. lamp) to the unit (Lout & N)
- Connect the power supply to the power connections of the PCB (L & N), see fig. 4.0.

👉 **Warning:** It is important to position jumper JP1 in the correct mode prior to connecting the kit to the AC power

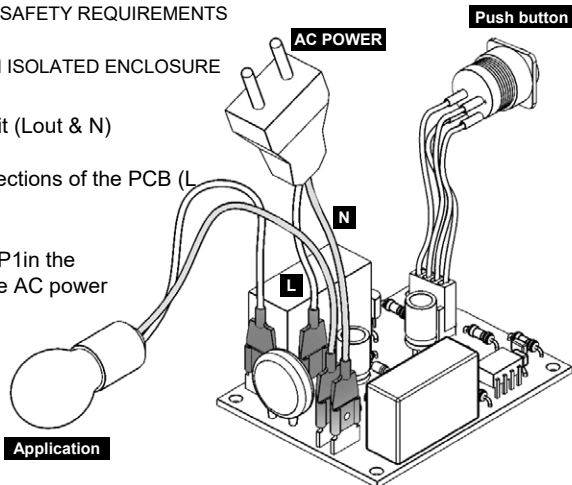

Fig. 4.0

👉 Never modify the JP1 mode setting while the unit is still live!

### **Jumper selection:**

First, choose the desired timer function, i.e. a long-term or a short-term timer.

#### (1) Long-term timer.

- Mount the jumper (JP1)
- At power-on, the pushbutton LED (or LD1) will flash slowly twice, hereby indicating that long-term timers have been selected (2h or 8h turn-off timer).

#### (2) Short-term timer.

- Remove the jumper (JP1)
- At power-on, the pushbutton LED (or LD1) will flash fast twice, hereby indicating that short-term timers have been selected (1h or 4h turn-off timer).

**Use :**

Push button briefly: turn-on relay and toggle between a short or a long turn-off delay.

- Short turn-off delay (1h or 4h, depending on setting of jumper JP1)
  - ✔ Pushbutton LED (or LD1) blinks fast.
  
- Long turn-off delay (2h or 8h, depending on setting of jumper JP2)
  - ✔ Pushbutton LED (or LD1) blinks slowly.

Hold button for 2-3s: turn-on relay and activate 24h turn-off timer.

- ✔ Pushbutton LED (or LD1) is steady lit

Hold button again for 2-3s: turn-off relay

- ✔ Pushbutton LED (or LD1) is dimly lit

## 20. Schematic diagram

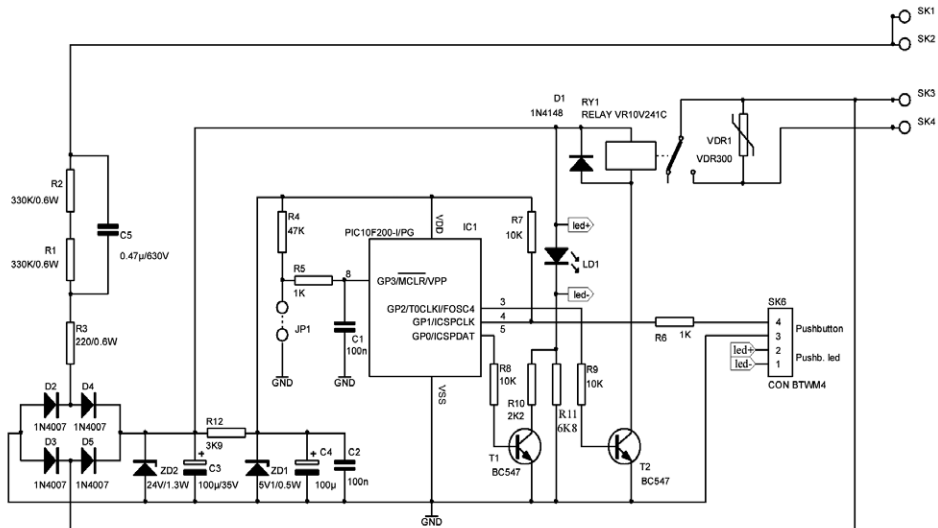

21. PCB

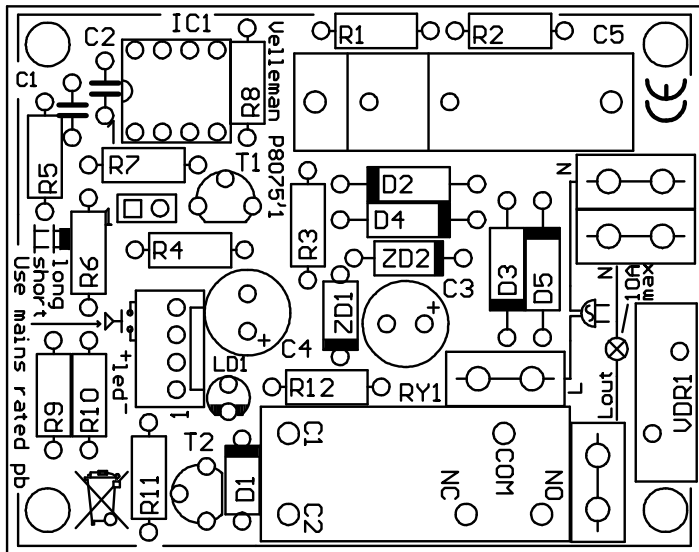

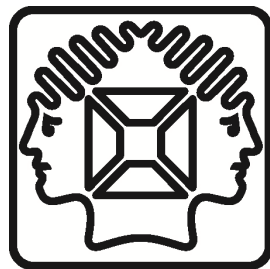

VELLEMAN NV  
Legen Heirweg 33, B-9890 GAVERE  
Belgium (Europe)

 @velleman\_RnD

