

Code lock

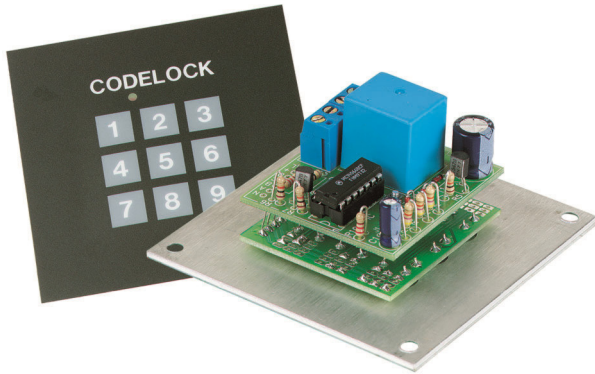

K6400

Get rid of those old fashioned keys

Features:

- More than 3000 codes possible.
- State indication by LED.
- Pulse or switch output.
- Nine digits of which 4 code digits.
- Secured against polarity reversal.

Specifications:

- Power supply : 9 to 15VDC or 8 to 12VAC.
- Relay output : 5A / 220V.
- Time limit for code determination : +/- 5sec.
- Current consumption :
 - Output OFF : 0,3 μ A
 - Output ON : 40mA

1. Assembly (Skipping this can lead to troubles !)

Ok, so we have your attention. These hints will help you to make this project successful. Read them carefully.

1.1 Make sure you have the right tools:

- A good quality soldering iron (25-40W) with a small tip.
- Wipe it often on a wet sponge or cloth, to keep it clean; then apply solder to the tip, to give it a wet look. This is called 'thinning' and will protect the tip, and enables you to make good connections. When solder rolls off the tip, it needs cleaning.
- Thin raisin-core solder. Do not use any flux or grease.
- A diagonal cutter to trim excess wires. To avoid injury when cutting excess leads, hold the lead so they cannot fly towards the eyes.
- Needle nose pliers, for bending leads, or to hold components in place.
- Small blade and Phillips screwdrivers. A basic range is fine.

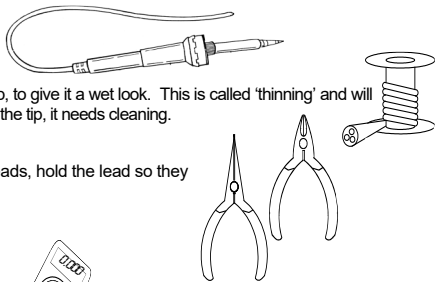

For some projects, a basic multi-meter is required, or might be handy



1.2 Assembly Hints :

- ⇒ Make sure the skill level matches your experience, to avoid disappointments.
 - ⇒ Follow the instructions carefully. Read and understand the entire step before you perform each operation.
 - ⇒ Perform the assembly in the correct order as stated in this manual
 - ⇒ Position all parts on the PCB (Printed Circuit Board) as shown on the drawings.
 - ⇒ Values on the circuit diagram are subject to changes.
 - ⇒ Values in this assembly guide are correct*
 - ⇒ Use the check-boxes to mark your progress.
 - ⇒ Please read the included information on safety and customer service
- * Typographical inaccuracies excluded. Always look for possible last minute manual updates, indicated as 'NOTE' on a separate leaflet.

1.3 Soldering Hints :

1- Mount the component against the PCB surface and carefully solder the leads

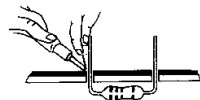

2- Make sure the solder joints are cone-shaped and shiny

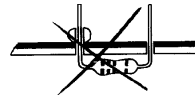
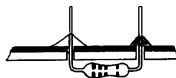

3- Trim excess leads as close as possible to the solder joint

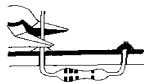

REMOVE THEM FROM THE TAPE ONE AT A TIME !

AXIAL COMPONENTS ARE TAPED IN THE CORRECT MOUNTING SEQUENCE !

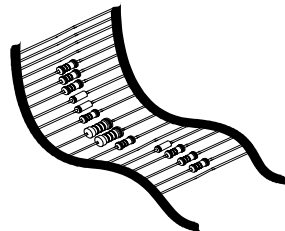

Assembly of the keyboard module : P6400S

1. Push button

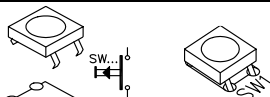

- | | |
|------------------------------|------------------------------|
| <input type="checkbox"/> SW1 | <input type="checkbox"/> SW6 |
| <input type="checkbox"/> SW2 | <input type="checkbox"/> SW7 |
| <input type="checkbox"/> SW3 | <input type="checkbox"/> SW8 |
| <input type="checkbox"/> SW4 | <input type="checkbox"/> SW9 |
| <input type="checkbox"/> SW5 | |

2. Led's. Watch the polarity!

LD1

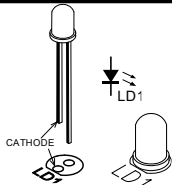

3. Determining the code

The four code digits are determined by fitting wire jumpers, see figure 1.0. Drawing 2 shows the connections for code 1234 as an example.

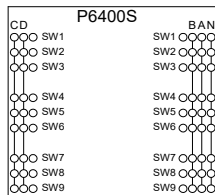

Fig. 1

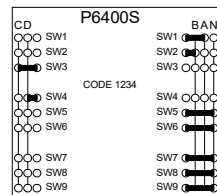

Fig. 2



Attention : the wire jumpers that build the code must be as close to the pcb as possible, because otherwise they will touch the aluminium front panel!

The code sequence is determined by connecting the lines A, respectively B, C and D to the connecting terminals (keys 1 through 9) at the inside of the pcb, where line A is the first code, B the second code and so on. The unused keys (normally 5) are connected to line N.

4. Preparation

Fit seven non insulated wires at the solder side of the pcb. These wires will be used later on for through connection to the master module (see fig. 3.0).

☞ **Attention** : the wires at the component side must be cut off as close to the pcb as possible.

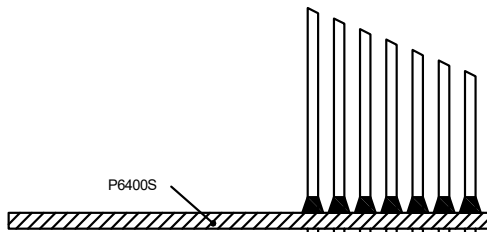

Fig. 3

Assembly of the Master module : P6400B

1. Jumpers

J

on/off function of the key lock.

J1

Fit wire jumper J1 in case you intend to use the **on/off function of the key lock**. If you don't fit this wire jumper, then, at the input of the code, the code lock will only generate a pulse (in general this mode is used with door locks).

"closed" contact or "open" contact .

NC or NO

Fit wire jumper NC if you intend to use the normally **"closed" contact** of the relay, or wire jumper NO if you intend to use the normally **"open" contact** of the relay.

👉 **ATTENTION** : after the relay has been fitted, these wire jumpers are no longer accessible.

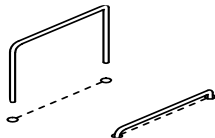

2. Diodes. Watch the polarity!

- D1 : 1N4148
- D2 : 1N4148
- D3 : 1N4148
- D4 : 1N4148
- D5 : 1N4007

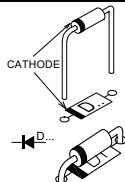

For D2 ... D4 :

👉 The side with the mark comes in the smallest hole marked C !

3. Resistors

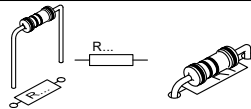

- R8 : 10 (1 - 0 - 0 - B)
- R9 : 220 (2 - 2 - 1 - B)
- R10 : 220 (2 - 2 - 1 - B)
- R11 : 1K5 (1 - 5 - 2 - B)

4. IC sockets, Watch the position of the notch!

IC1 : 14p

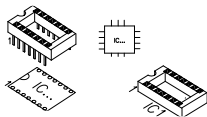

5. Transistor

T1 : BC547B
 T2 : BC547B

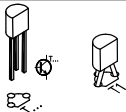

6. Resistors

R1 : 470K (4 - 7 - 4 - B)
 R2 : 47K (4 - 7 - 3 - B)
 R3 : 47K (4 - 7 - 3 - B)
 R4 : 47K (4 - 7 - 3 - B)
 R5 : 10K (1 - 0 - 3 - B)
 R6 : 10K (1 - 0 - 3 - B)
 R7 : 10K (1 - 0 - 3 - B)



7. Electrolytic capacitor. Watch the polarity !

C1 : 10 μ F
 C2 : 470 μ F

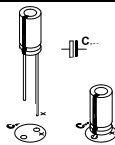

8. Screw connectors

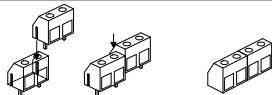

J2 : 2p + 2p

9. Relay

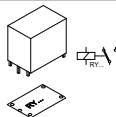

RY1 : VR15M121C

10. IC. Check the position of the notch!

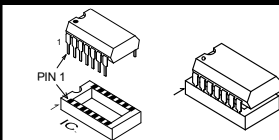

IC1 : CD4066

Final Assembly



CHECK THE WHOLE MOUNTING ONCE MORE THOROUGHLY AND DON'T FORGET THE CODE, BECAUSE AFTER THE FOLLOWING ASSEMBLY IT WON'T BE ACCESSIBLE ANY MORE.

- Pass two 2mm bolts through the front panel and fix them using a nut.
- Then pass a lock washer over the bolts followed by the keyboard module. Take care that the LED is in the front panel.

☞ Normally, neither the LED nor the push buttons may pass through the front panel. The push buttons must be flush with the front side.

- Pass a 10mm distance tube over the two bolts, followed by the master module. Also take care that the through connections pass through the master module.
- Now fix both modules using two nuts, where after you can solder the through connections (pay attention to short-circuits).

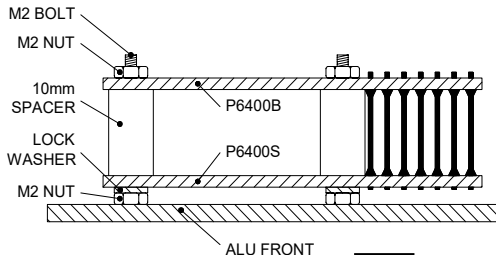

Fig. 4

Test & usage

Connect a 9 to 15VDC or a 8 to 12VAC to the points V and GND. (V is the plus pole in the case of direct current).

Put the front panel film next to the keyboard and enter the right code (in the case of a pulse output this has to be done within 5 seconds). If everything is going on well, now the relay should close and open again in case pulse output mode has been selected. If however you have chosen for a constant switch position, then you can cause the relay to open by entering a digit NOT belonging to the code digits.

Tip: should the opening time of the relay (in the case of the pulse output mode) be too short, fit a 22 μ F capacitor instead of C1 to change that time.

Building in

In case you use the key lock outside, it is advisable to mount it sunk, so that no water can soak in. For safety you better first fix the code lock into the wall where after you stick the film to it, so that the fixation screws are hidden "behind" the film.

Take care that, when sticking the film, the "LED WINDOW" corresponds with the hole in the aluminium.

Schematic diagram (Control section)

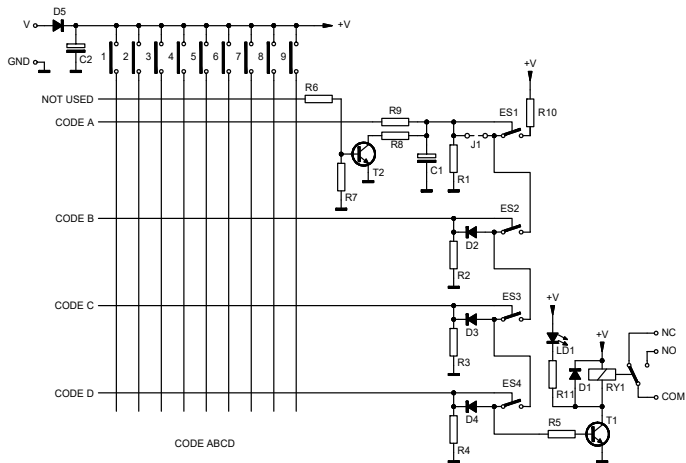

PCB

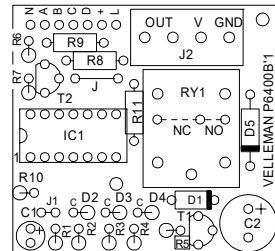
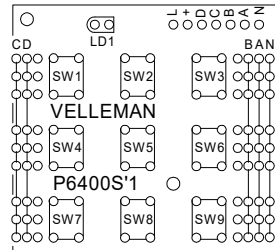

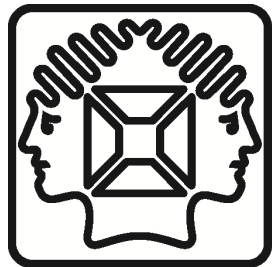

VELLEMAN NV
Legen Heirweg 33, B-9890 GAVERE
Belgium (Europe)

 @velleman_RnD

Modifications and typographical errors reserved © Velleman nv.
H6400IP'2 - 2014 (rev.2.0)

