

Total solder points: 108

Difficulty level: *beginner* 1 2 3 4 5 *advanced*

QUAD TRIAC SWITCH CARD

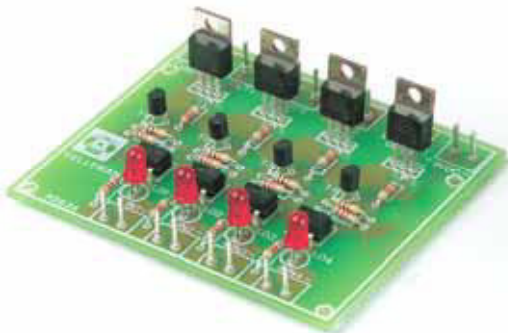

K2634

Control up to 4 high-power circuits
from a low-power drive circuit.

Applying relays is the most usual way to switch an alternating current (AC) with an electronic control, because of its simplicity and its security, as the switching and switched voltage are completely separated. The low speed (esp. for illuminated advertisements) and the short life of the contacts are however major disadvantages. In order to avoid the disadvantages of the relay without losing the advantages, optocoupler controlled triacs are used. Because of the fact that the outputs are controlled by current instead of voltage, they are less sensitive to input interferences, so that the triac card can easily be mounted near the load and relatively far from the control circuit (e.g. for score boards etc.).

This kit can immediately be connected to cards like: K8000, K8050, K8023, K8055, K8046, K8055 or other cards with open collector output. Circuits which can deliver a control current of 10mA or higher can also be used.

Features:

- Four triac outputs
- Inputs galvanically isolated by optocouplers.
- 4 control LED's are provided

Specifications:

- Load : 24 to 240V AC, 0,5 A not cooled (max. 4A) per output.
- Control current : 10 to 20mA DC.
- 9V DC/200mA ISOLATED FROM THE MAIN VOLTAGE (isolated winding or another transformer).
- Dimensions : 78 x 90 x 29 mm

1. Assembly (Skipping this can lead to troubles !)

Ok, so we have your attention. These hints will help you to make this project successful. Read them carefully.

1.1 Make sure you have the right tools:

- A good quality soldering iron (25-40W) with a small tip.
- Wipe it often on a wet sponge or cloth, to keep it clean; then apply solder to the tip, to give it a wet look. This is called 'thinning' and will protect the tip, and enables you to make good connections. When solder rolls off the tip, it needs cleaning.
- Thin raisin-core solder. Do not use any flux or grease.
- A diagonal cutter to trim excess wires. To avoid injury when cutting excess leads, hold the lead so they cannot fly towards the eyes.
- Needle nose pliers, for bending leads, or to hold components in place.
- Small blade and Phillips screwdrivers. A basic range is fine.

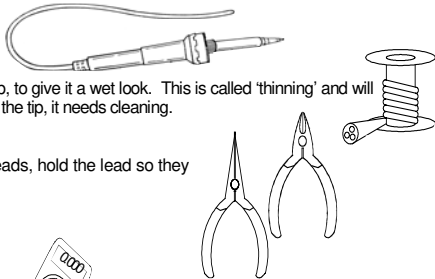

For some projects, a basic multi-meter is required, or might be handy

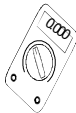

1.2 Assembly Hints :

- ⇒ Make sure the skill level matches your experience, to avoid disappointments.
 - ⇒ Follow the instructions carefully. Read and understand the entire step before you perform each operation.
 - ⇒ Perform the assembly in the correct order as stated in this manual
 - ⇒ Position all parts on the PCB (Printed Circuit Board) as shown on the drawings.
 - ⇒ Values on the circuit diagram are subject to changes.
 - ⇒ Values in this assembly guide are correct*
 - ⇒ Use the check-boxes to mark your progress.
 - ⇒ Please read the included information on safety and customer service
- * Typographical inaccuracies excluded. Always look for possible last minute manual updates, indicated as 'NOTE' on a separate leaflet.

1.3 Soldering Hints :

1- Mount the component against the PCB surface and carefully solder the leads

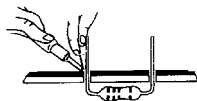

2- Make sure the solder joints are cone-shaped and shiny

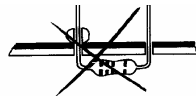
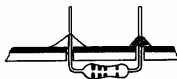

3- Trim excess leads as close as possible to the solder joint

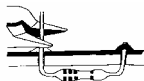

REMOVE THEM FROM THE TAPE ONE AT A TIME !

AXIAL COMPONENTS ARE TAPED IN THE CORRECT MOUNTING SEQUENCE !

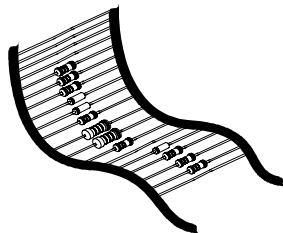

1. Resistors

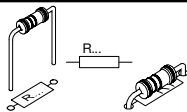

- | | |
|---|--|
| <input type="checkbox"/> R1 : 220 (2 - 2 - 1 - B) | <input type="checkbox"/> R7 : 10K (1 - 0 - 3 - B) |
| <input type="checkbox"/> R2 : 220 (2 - 2 - 1 - B) | <input type="checkbox"/> R8 : 10K (1 - 0 - 3 - B) |
| <input type="checkbox"/> R3 : 220 (2 - 2 - 1 - B) | <input type="checkbox"/> R9 : 12K (1 - 2 - 3 - B) |
| <input type="checkbox"/> R4 : 220 (2 - 2 - 1 - B) | <input type="checkbox"/> R10 : 12K (1 - 2 - 3 - B) |
| <input type="checkbox"/> R5 : 10K (1 - 0 - 3 - B) | <input type="checkbox"/> R11 : 12K (1 - 2 - 3 - B) |
| <input type="checkbox"/> R6 : 10K (1 - 0 - 3 - B) | <input type="checkbox"/> R12 : 12K (1 - 2 - 3 - B) |

For use with a regular open collector output and a control voltage of 9 to 15VDC :

Rx : 820 (8 - 2 - 1 - B)

☞ If your control voltage is higher, then a higher value resistor must be used.

For 24Vdc :

Rx : 1K8 (1 - 8 - 2 - B)

2. IC's.

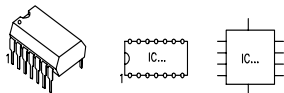

- IC1 : TIL111 or equivalent
- IC2 : TIL111 or equivalent
- IC3 : TIL111 or equivalent
- IC4 : TIL111 or equivalent

☞ Mind the position of the notch : it should point to the Velleman emblem.

3. Transistors

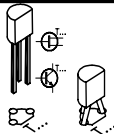

- T1 : BC547B
- T2 : BC547B
- T3 : BC547B
- T4 : BC547B

4. PCB tabs

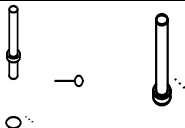

- | | |
|-----------------------------------|----------------------------------|
| <input type="checkbox"/> VAC :2X | <input type="checkbox"/> IN1 :2X |
| <input type="checkbox"/> OUT1 :2X | <input type="checkbox"/> IN2 :2X |
| <input type="checkbox"/> OUT2 :2X | <input type="checkbox"/> IN3 :2X |
| <input type="checkbox"/> OUT3 :2X | <input type="checkbox"/> IN4 :2X |
| <input type="checkbox"/> OUT4 :2X | |
| <input type="checkbox"/> 9VDC :2X | |

☞ You can also use terminal connectors.

5. LED. Watch the polarity!

- | | |
|------------------------------|-----------|
| <input type="checkbox"/> LD1 | } 5mm Red |
| <input type="checkbox"/> LD2 | |
| <input type="checkbox"/> LD3 | |
| <input type="checkbox"/> LD4 | |

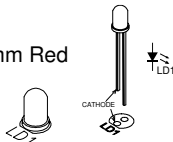

6. Triacs

- TRI1: TIC206M
- TRI2: TIC206M
- TRI3: TIC206M
- TRI4: TIC206M

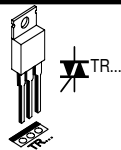

- ☞ **Remarks :** Make sure the metal backside of the triacs points to the outputs.
- ☞ Apply a layer of tin on the entire PCB track.

If you want to switch more than 1,5A per output, then the triacs need cooling.

- You therefore have to mount heatsinks to the triacs. If you mount all the triacs on the same heatsink, then you have to isolate the triacs with mica plates and special plastic washers.

The PCB tacks interconnecting the output connectors and the triacs are not protected by the red solder mask. We advise you to strengthen these in soldering a copper wire of 1,5mm² along the whole print. We must take into account that the entire load current goes through these connections; so up to 4A, if the triacs are cooled !

7. Connection

- ❑ Connect the minus side of the inputs to the open collector outputs of the interface card(s) (see fig.1).
- ❑ Connect the positive side of all inputs with a control voltage (ex. +9Vdc to 12Vdc). The negative (GND) of the control voltage must also be connected to the Common (or GND) of the open collector card.
- ☞ Keep in mind that EACH input of the triac card takes about 12mA from the power supply !

☞ **This control voltage has to be COMPLETELY ISOLATED!**

- ☞ To supply the card a separate supply must be used of 9Vdc (see fig. 1)

- ❑ Connect the supply for the loads to the points VAC. It may range between 24 and 240 VAC.

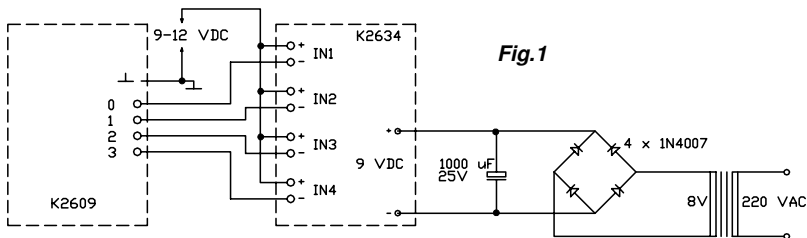

☞ **ATTENTION** : everything on the print from the optocouplers to the output side is subjected to this (eventual) hazardous voltage.

The loads are connected to OUT1 and OUT4.

Interferences on the mains are possible because of the fact that the load switching does not necessarily takes place on the zero crossing point of the AC. When this should disturb the computer functioning, we advise you to install the triac card near the loads to be switched.

8. Schematic diagram.

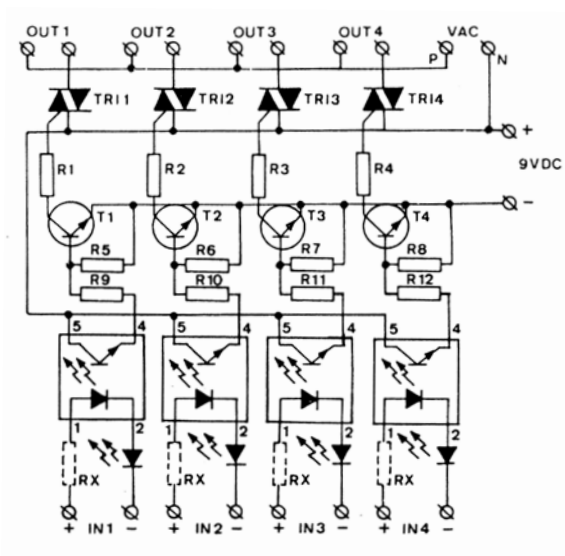

9. PCB

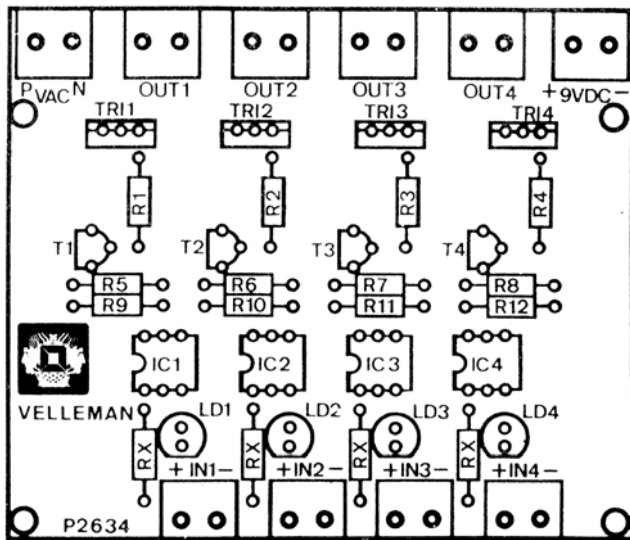



Modifications and typographical errors reserved
© Velleman Components nv.
H2634IP - 2003 - ED1

