

# LTECH

## EX Series Touch Panel



EX1S  
[Dimming]



EX2  
[CT]



EX4S  
[RGBW]



Q series remote



F series remote



APP

Manual  
[www.ltech-led.com](http://www.ltech-led.com)

# LTECH

## System diagram

### L-BUS

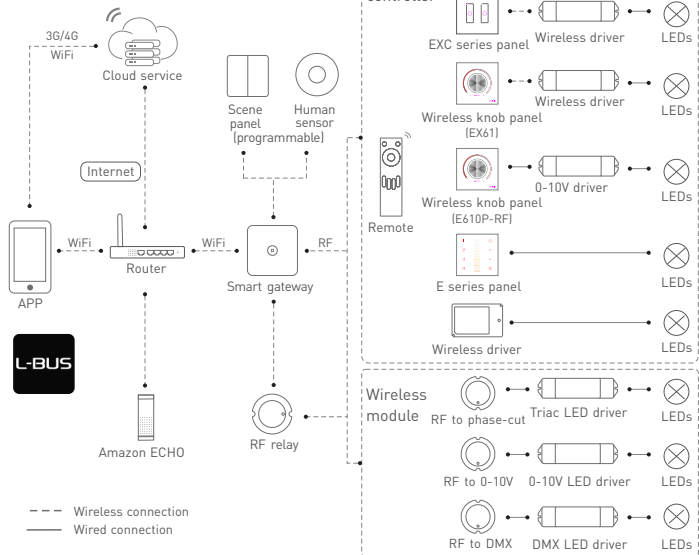

EX series touch panel

## Product features





- Adopt wireless RF and wired DMX512 protocol 2 in 1 control mode, more flexible and convenient for project installation.
- Advanced RF wireless sync/zone control technology, make sure dynamic color modes synchronously among multiple drivers.
- Install touch panel at different areas, can control the same LED light, achieve multi-panel control, no quantity limited.
- Touch keys with chord and LED indicator.
- Adopts capacitive touch control technology makes LED dimming selection more user-friendly.
- Compatible with remote and APP control with adding LTECH gateway.

## Technical specs

Model	EX1S	EX2	EX4S
Control type	Dimming	CT	RGBW
Input voltage	100-240Vac		
Output signal	DMX512		
Wireless type	RF 2.4GHz		
Working temp.	-20°C~55°C		
Dimensions	L86×W86×H36(mm)		
Package size	L113×W112×H50(mm)		
Weight[G.W.]	225g		

\* Product with **L-BUS** logo, supports the function of WIFI-108 advanced mode.

## Key functions

- \* When blue indicator light of  key is on, long press  to turn on/off buzzer. When white indicator light of  key is on, long press  to match code.
- \* EX panel's scene-mode keys are corresponding with gateway APP's scenes, the scenes can be changed by APP or panel.

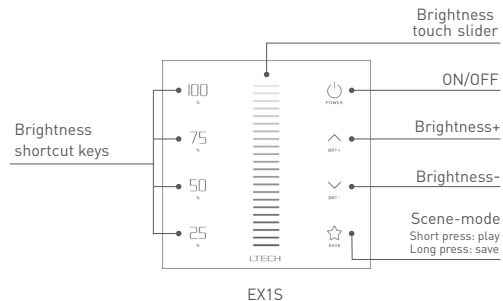

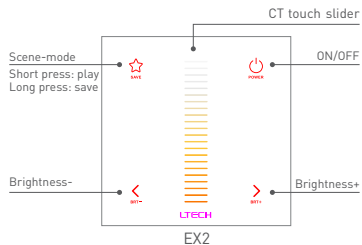

CT & CT2 mode of EX2 panel switch to each other:  
Simultaneously long press button and button for 3 seconds, the buzzer beeps once then switch successfully.

( Factory default: CT mode )

Modes DMX Addresses	CT	CT2
1	C	BRT
2	W	CT

\*Please switch the color temperature mode when the switch indicator light is white.

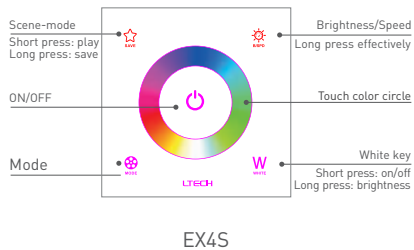

### Mode

1. Static red
2. Static green
3. Static blue
4. Static yellow
5. Static purple
6. Static cyan
7. Static white
8. RGB jumping
9. 7 Colors jumping
10. RGB color smooth
11. Full-color smooth
12. Static black (only close RGB)

\* White light only: press key to choose black mode, then press **W** key.

## Product size

Unit: mm

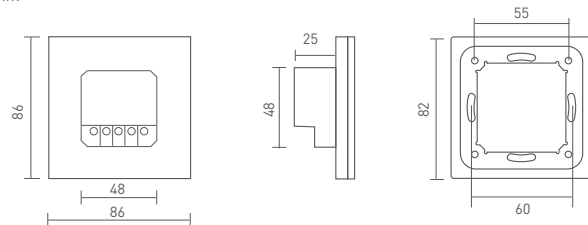

## Terminals

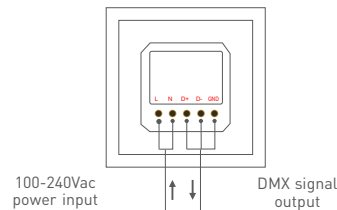

## Installation instruction

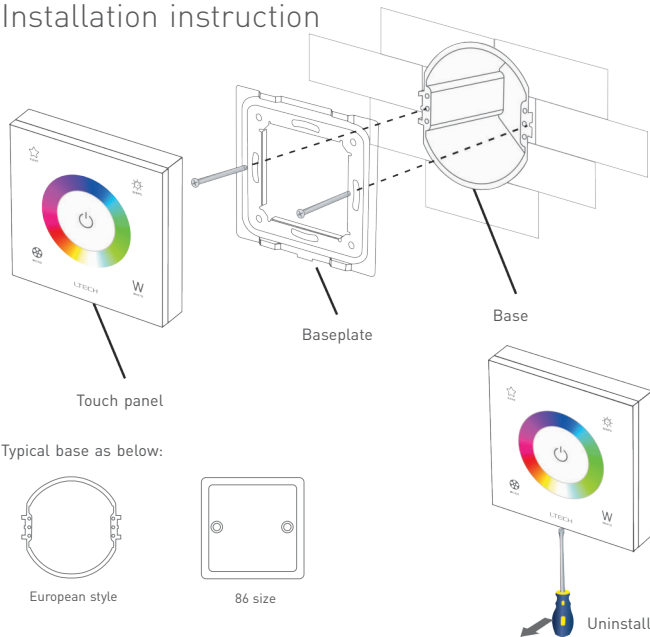

## Match code sequence

### DMX system wiring

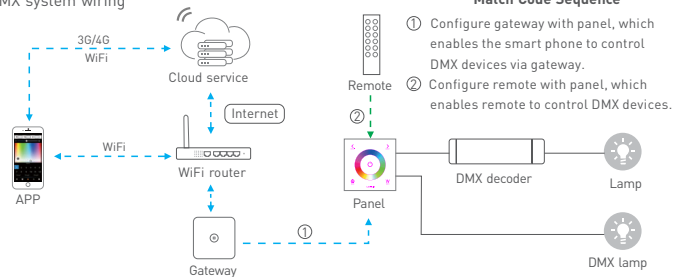

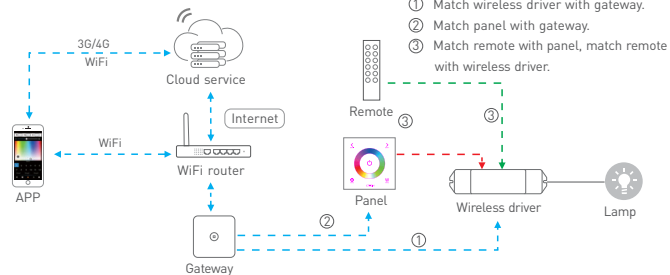

### Wireless system wiring



## Application composition

### DMX512 control

- 

1. Touch panel + DMX driver + Lamp
- 

2. Remote + Touch panel + DMX driver + Lamp
- 

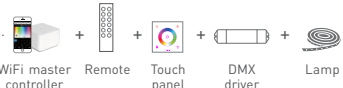
3. WiFi master controller + Touch panel + DMX driver + Lamp
- 

4. WiFi master controller + Remote + Touch panel + DMX driver + Lamp

### Wireless control

- 

1. Touch panel + Wireless driver + Lamp
- 

2. Remote + Touch panel + Wireless driver + Lamp
- 

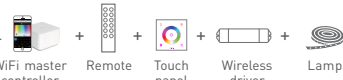
3. WiFi master controller + Touch panel + Wireless driver + Lamp
- 

4. WiFi master controller + Remote + Touch panel + Wireless driver + Lamp

## DMX wiring

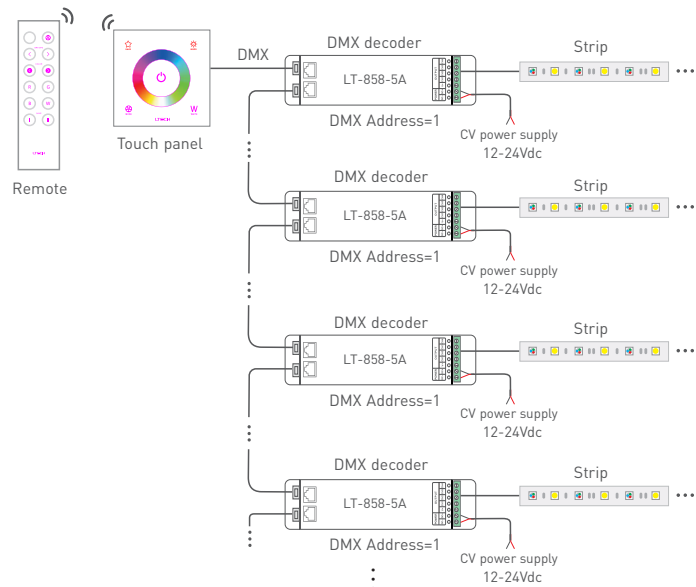

## RF wireless wiring



Touch panel

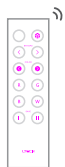

Remote

Multiple wireless receivers (F4-3A/F4-5A/F4-DMX-5A/F5-DMX-4A) can be matched with EX series touch panel within effective distance.

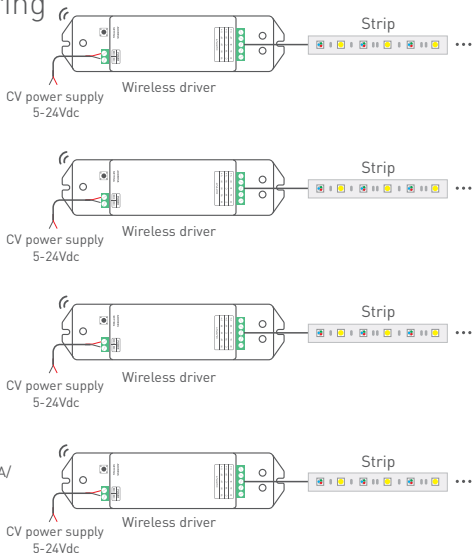

**To avoid the signal interference, the installation needs to keep away from the large area metal material or the metal material space.**

## Multi-panel control wiring

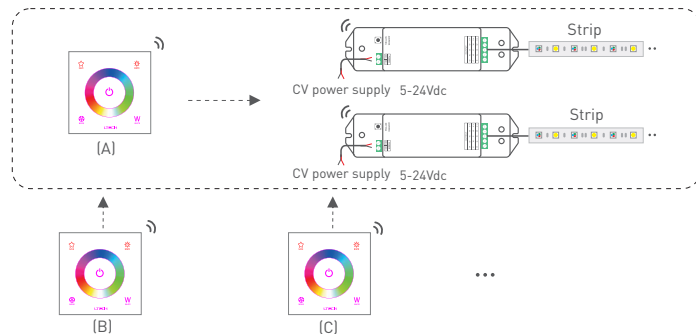

\* After touch panel A realizes controlling the lamps, if B and C are matched with A, they can also control the lamps.

\* Linkage control is also available at connecting with DMX decoders.

## Match code between touch panels

1. Assuming that B matches with A, long press  on B until all indicator lights flicker.



2. Touch the slider on A within 15s, when indicator lights of B stop flickering, match successfully.



## Match code between touch panel & remote

1. Long press  on touch panel until all indicator lights flicker.

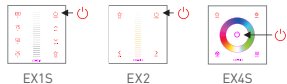

### 2. Match with F series remote:

Long press On/Off key on F series remote, the indicator light of touch panel stop flicking, match successfully.

- EX1S works with remote F1.
- EX2 works with remote F2.
- EX4S works with remote F4.

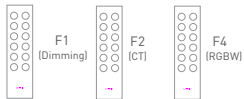

### Match with Q series remote:

Long press the matching zone's "On" key on Q series remote, the indicator light of touch panel stop flicking, match successfully.

- EX1S works with remote Q1.
- EX2 works with remote Q2.
- EX4S works with remote Q4.



\* Please match/clear code when  indicator light of panel is white.

## Match code between touch panel & wireless driver

Touch panels can work with wireless driver F4-3A/F4-5A/F4-DMX-5A/F5-DMX-4A.

### Method 1:

1. Power off the driver.
2. Long press On/Off key of the panel until all indicator light flicking.
3. Power on the driver, the lamps flicker slowly, please complete step 4 within 15s.
4. Short press any key or color circle / slider on the panel, match successfully.



### Method 2:

1. Short press "ID learning button" on wireless driver, the lamps flicker, please complete next step within 15s.
2. Long press On/Off key on panel until all indicator light flicker.
3. Short press any key or color circle / slider on the panel, match successfully.



\* Please match/clear code when  indicator light of panel is white.

## Match code between touch panel & gateway

1. Long press  on touch panel until indicator lights flicker.

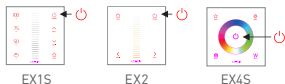

2. Turn on APP, enter "zone set" interface, click the right top "MATCH" key, then follow the prompts.



## Clear code

Press the bottom two key on touch panel simultaneously for 6s, the indicator lights flicker several times, clear code successfully.



\* Please match/clear code when  indicator light of panel is white.

## Warranty agreement

1. We provide lifelong technical assistance with this product:

- A 5-year warranty is given from the date of purchase. The warranty is for free repair or replacement if cover manufacturing faults only.
- For faults beyond the 5-year warranty, we reserve the right to charge for time and parts.

2. Warranty exclusions below:

- Any man-made damages caused from improper operation, or connecting to excess voltage and overloading.
- The product appears to have excessive physical damage.
- Damage due to natural disasters and force majeure.
- Warranty label, fragile label and unique barcode label have been damaged.
- The product has been replaced by a brand new product.

3. Repair or replacement as provided under this warranty is the exclusive remedy to the customer. LTECH shall not be liable for any incidental or consequential damages for breach of any stipulation in this warranty.

4. Any amendment or adjustment to this warranty must be approved in writing by LTECH only.

\* No further notice if any changes in the manual.  
Product function depends on the goods.  
Please feel free to contact our official distributor if any question.