

# LTECH

## WiFi LED CONTROLLER

Model : WiFi-102-RGBW

WiFi-102-CT

### Operating Instruction

## System Diagram

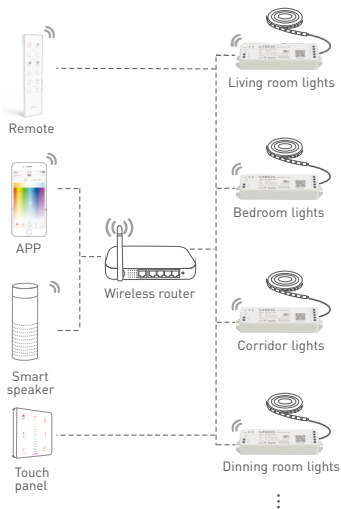

### Match code between panel / remote & WiFi LED controller:

After WiFi LED controller matched up with a router, brush it out in APP and enter the main control interface, click the "+" key in the upper right corner to enter next interface, find the appropriate model and match code according to the prompt.

# Product Parameters

WiFi LED controller can be connected with lamps directly, support remote control via intelligent device, mobile phone, remote and touch panel etc., flexible application makes life more intelligent.

Model	WiFi-102-RGBW	WiFi-102-CT
Product Name	WiFi LED Controller	
Input Voltage	12 ~ 24Vdc	
Out Control	RGBW LED lights	CT LED lights
Current Load	3A x 4CH Max. 12A	Max. 6A
Output Power	[0~36...72W]x4CH	0~72W...144W
Network Type	WiFi 2.4GHz , IEEE 802.11b/g/n	
RF Frequency	2.4GHz	
Working Temp.	-30°C ~ +55°C	
Dimension	L125 x W33 x H20(mm)	
Packing	L127 x W35 x H24(mm)	
Gross Weight	70g	

# Product Structure

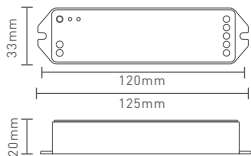
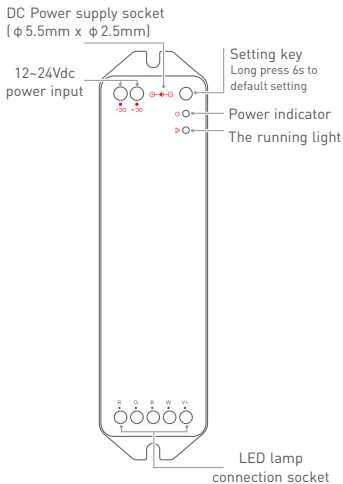

## Product Installation

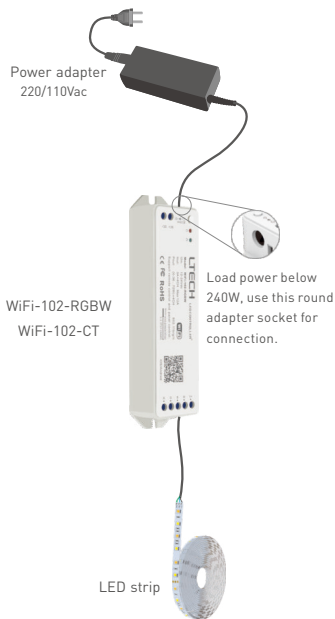

## Operating Guidance

- 1 Open WLAN via mobile phone, connect to the wireless router.

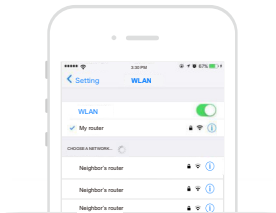

- 2 Scan QR Code to download the APP via mobile phone.



iOS / Android

- 3 After installation, the strip flashes within 30s when powered on and then the controller is ready to the configuration status accordingly.

4 Turn on APP, click ⊕ icon on the right top corner.

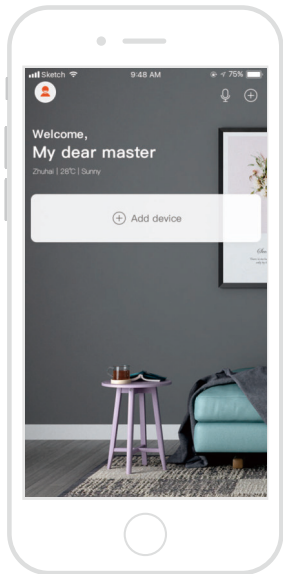

5 Enter the interface "Add Device", choose "Color light" or "CT light" and follow the prompts to connect.

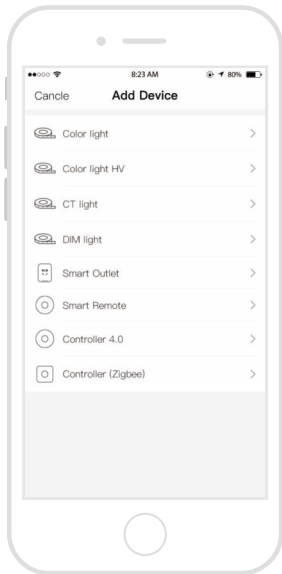

- 6 Once successfully connect to the device that will immediately open intelligent life and realize long-distance control via mobile phone.

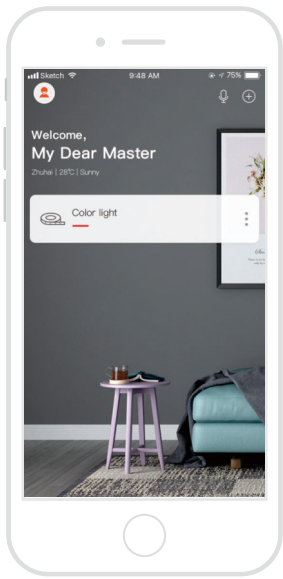

## Attention

- 1.The product shall be installed and serviced by the qualified person.
- 2.This product is non-waterproof. Please avoid the sun and rain. When installed outdoors, please ensure it is mounted in a water proof enclosure.
- 3.Good heat dissipation will prolong the life time of the controller. Please ensure good ventilation.
- 4.Please check if the output voltage of the LED power supply used comply with the working voltage of the product.
5. Please make sure the diameter of the wire must be sufficient to load the connected LED lights with firm wire connection.
- 6.Ensure all wire connections and polarities are correct before connecting with power to avoid any damages to the LED lights.
- 7.If errors caused, please do not attempt to fix this product by yourself, please contact the supplier.

★ This manual only applies to this model. We reserve the right to make changes without prior notice.