

Gegevensblad | Artikelnummer: 221-612

COMPACT Splicing Connector; for all conductor types; max. 6 mm²; 2-conductor; with levers; transparent housing; Surrounding air temperature: max 85°C (T85); 6,00 mm²; transparent

www.wago.com/221-612



RoHS Compliant

[BOMcheck.net](https://www.bomcheck.net)

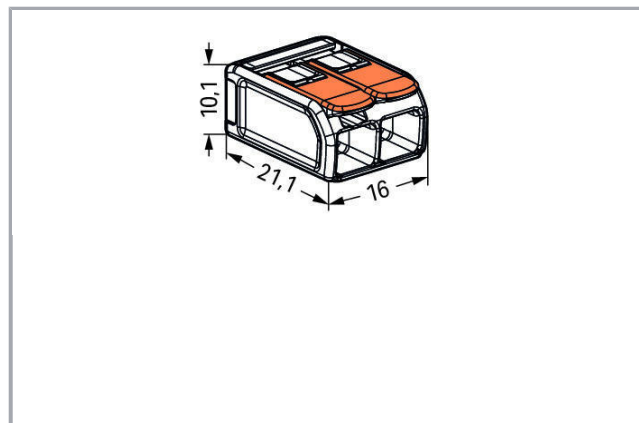

Wijzigingen voorbehouden. Let ook op de verdere productdocumentatie!

WAGO BeLux nv
Excelsiorlaan 11
1930 Zaventem
Telefoon.: +32 (0)2 717 90 90 | Fax: +32 (0)2 717 90 99
E-mail: info-be@wago.com | Web: www.wago.be

Hebt u vragen over onze producten?
U kunt ons telefonisch bereiken op het nr. +32 (0) 2 7179090.



Artikelbeschrijving

Your Benefits:

- Ease of use – pull the lever up, insert a conductor and push the lever back down
- Available as 2-, 3- and 5-wire connectors
- Easily terminate conductors from 0.5 to 6 mm²
- Connection of all conductor types
- Time savings for installers and device manufacturers
- Quickly install devices with higher levels of power consumption
- Safely install long cable runs with larger conductor cross sections
- Mounting carrier for installation conforms to standards
- Custom carriers are possible

Safety information 1:

in grounded power lines

Gegevens

Electrical data

Wijzigingen voorbehouden. Let ook op de verdere productdocumentatie!

WAGO BeLux nv
Excelsiorlaan 11
1930 Zaventem
Telefoon.: +32 (0)2 717 90 90 | Fax: +32 (0)2 717 90 99
E-mail: info-be@wago.com | Web: www.wago.be

Hebt u vragen over onze producten?
U kunt ons telefonisch bereiken op het nr. +32 (0) 2 7179090.



Ratings per IEC/EN 60664-1

Ratings per	EN 60664
Nominal voltage (II/2)	450 V
Rated surge voltage (II/2)	4 kV
Rated current	41 A
Legend (ratings)	(II / 2) \triangleq Overvoltage category II / Pollution degree 2

Approvals per UL 1059

Rated voltage UL (Use Group C)	600 V
Rated current UL (Use Group C)	30 A

Connection data

Connection technology	CAGE CLAMP [®]
Actuation type	Lever
Connectable conductor materials	Copper
Nominal cross-section	6 mm ²
Solid conductor	0.5 ... 6 mm ² / 20 ... 10 AWG
Stranded conductor	0.5 ... 6 mm ² / 20 ... 10 AWG
Fine-stranded conductor	0.5 ... 6 mm ² / 20 ... 10 AWG
Strip length	12 ... 14 mm / 0.47 ... 0.55 inch
Total number of connection points	2
Total number of potentials	1
Wiring type	Side-entry wiring

Geometrical Data

Width	16 mm / 0.63 inch
Height	10.1 mm / 0.398 inch
Depth	21.1 mm / 0.831 inch

Material Data

Color	transparent
Flammability class per UL94	V2
Color of actuator	orange
Weight	3 g

Wijzigingen voorbehouden. Let ook op de verdere productdocumentatie!

WAGO BeLux nv
 Excelsiorlaan 11
 1930 Zaventem
 Telefoon.: +32 (0)2 717 90 90 | Fax: +32 (0)2 717 90 99
 E-mail: info-be@wago.com | Web: www.wago.be

Hebt u vragen over onze producten?
 U kunt ons telefonisch bereiken op het nr. +32 (0) 2 7179090.

Environmental Requirements

Surrounding air temperature (operation)	85 ... 85 °C
Continuous operating temperature	105 ... 105 °C
Temperature marking per EN 60998	T85

Commercial data



Packaging type	BOX
Country of origin	CH
GTIN	4055143704168
Customs tariff number	85369010000

Vergunningen / certificaten

Country specific Approvals

Logo	Vergunning	Norm	Certificaatsnaam
	KEMA/KEUR DEKRA Certification B.V.	EN 60998	71-105677

Ship Approvals

Logo	Vergunning	Norm	Certificaatsnaam
	ABS American Bureau of Shipping	EN 60998	18-HG1755093-PDA
	DNV GL Det Norske Veritas, Germanischer Lloyd	EN 60998	TAE000015T
	LR Lloyds Register	EN 60998	04/20013 (E8)

UL-Approvals

Logo	Vergunning	Norm	Certificaatsnaam
	UL Underwriters Laboratories Inc.	UL 486C	E69654

Wijzigingen voorbehouden. Let ook op de verdere productdocumentatie!

WAGO BeLux nv
Excelsiorlaan 11
1930 Zaventem
Telefoon.: +32 (0)2 717 90 90 | Fax: +32 (0)2 717 90 99
E-mail: info-be@wago.com | Web: www.wago.be

Hebt u vragen over onze producten?
U kunt ons telefonisch bereiken op het nr. +32 (0) 2 7179090.



UL
Underwriters Laboratories Inc.

UL 467

E201573

Relevante producten

Mounting adapter



Artikelnummer: 221-510

Mounting carrier; 221 Series - 6 mm²; for DIN-35 rail mounting/screw mounting; orange

www.wago.com/221-510



Artikelnummer: 221-510/000-006

Mounting carrier; 221 Series - 6 mm²; for DIN-35 rail mounting/screw mounting; blue

www.wago.com/221-510/000-006



Artikelnummer: 221-510/000-053

Mounting carrier; 221 Series - 6 mm²; for DIN-35 rail mounting/screw mounting; dark gray-yellow

www.wago.com/221-510/000-053

Downloads

Documentation

Bid Text

221-612 GAEB docx - Datei	23-jan-2019	docx 16,0 kB	Download
221-612 GAEB X81 - Datei	19-feb-2019	xml 3,6 kB	Download

Additional Information

Technical explanations	3-apr-2019	pdf 2,1 MB	Download
------------------------	------------	---------------	----------

CAD/CAE-Data

CAD data

2D/3D Models 221-612	URL	Download
----------------------	-----	----------

CAE data

ZUKEN Portal 221-612	URL	Download
----------------------	-----	----------

Wijzigingen voorbehouden. Let ook op de verdere productdocumentatie!

WAGO BeLux nv
Excelsiorlaan 11
1930 Zaventem
Telefoon.: +32 (0)2 717 90 90 | Fax: +32 (0)2 717 90 99
E-mail: info-be@wago.com | Web: www.wago.be

Hebt u vragen over onze producten?
U kunt ons telefonisch bereiken op het nr. +32 (0) 2 7179090.

Gebruiksaanwijzingen

Conductor termination

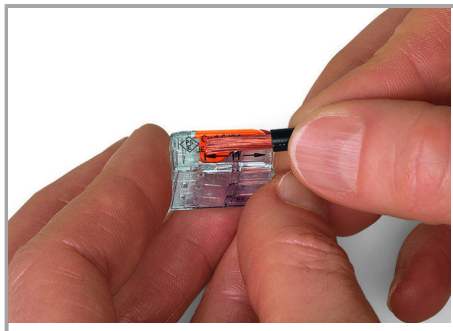

Strip conductor to 11 mm (0.43 inch).

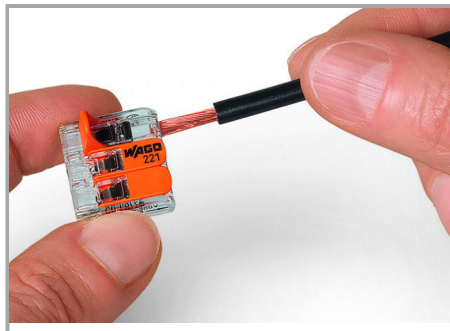

Termination: Lift the lever to open the clamping unit and insert a stripped conductor.

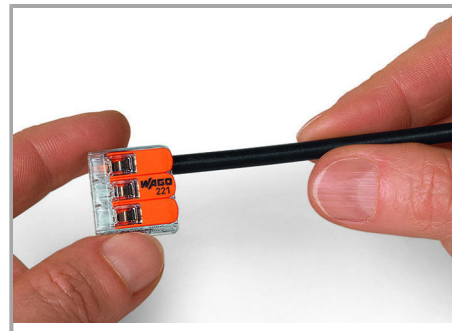

Then, lower the lever to close the clamp.

Application

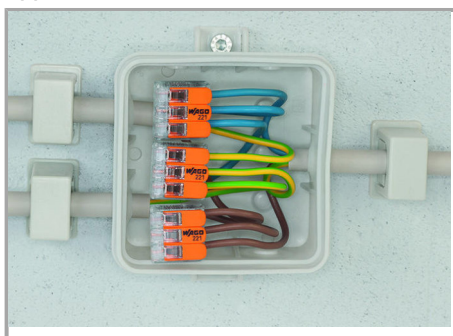

Wiring fine-stranded conductors in a junction box.

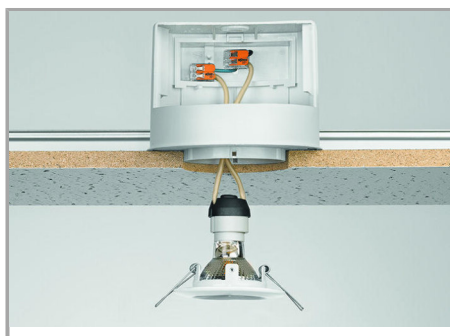

Custom low-voltage lighting system



Lighting distribution in ceiling canopy

Wijzigingen voorbehouden. Let ook op de verdere productdocumentatie!

WAGO BeLux nv
Excelsiorlaan 11
1930 Zaventem
Telefoon.: +32 (0)2 717 90 90 | Fax: +32 (0)2 717 90 99
E-mail: info-be@wago.com | Web: www.wago.be

Hebt u vragen over onze producten?
U kunt ons telefonisch bereiken op het nr. +32 (0) 2 7179090.



Pendant light connection in suspended ceilings

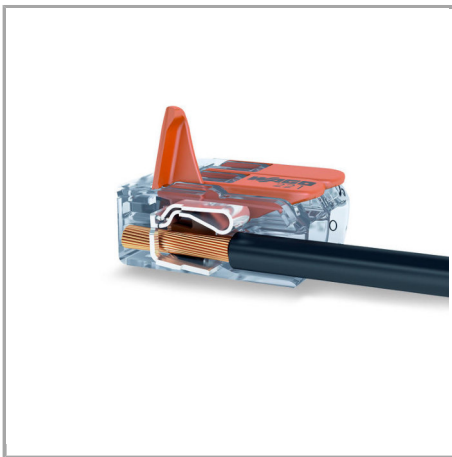

COMPACT Splicing Connectors for All Conductor Types, 4 mm² (12 AWG), 221 Series

Wijzigingen voorbehouden. Let ook op de verdere productdocumentatie!