

Total solder points: 131

Difficulty level: *beginner* 1 2 3 4 5 *advanced*

AUDIO / VIDEO MODULATOR



K4601

Convert an audio and video signal into a UHF TV signal.

If it is desired to connect a video signal originating from a camera or other video source to a normal TV set, you will need this modulator. The audio and video signal is converted into a UHF TV signal so that the signal can be received through the TV antenna input. In certain countries (find out from your national telecommunications authority) it is permitted to use this modulator as a mini-transmitter by connecting a small antenna to it. With this facility it is possible to receive the signal from the video recorder or camera elsewhere within your home (range 30m, 98' approx.). The kit comes complete with housing and antenna connector.

Specifications :

- Input: audio and video.
- Output: UHF channel 21 (450 - 500MHz adjustable).
- Power supply: 12 to 15VDC / 100mA.
- Dimensions: 70 x 104 x 30mm (2.8" x 4.1" x 1.2").

1. Assembly (Skipping this can lead to troubles !)

Ok, so we have your attention. These hints will help you to make this project successful. Read them carefully.

1.1 Make sure you have the right tools:

- A good quality soldering iron (25-40W) with a small tip.
- Wipe it often on a wet sponge or cloth, to keep it clean; then apply solder to the tip, to give it a wet look. This is called 'thinning' and will protect the tip, and enables you to make good connections. When solder rolls off the tip, it needs cleaning.
- Thin raisin-core solder. Do not use any flux or grease.
- A diagonal cutter to trim excess wires. To avoid injury when cutting excess leads, hold the lead so they cannot fly towards the eyes.
- Needle nose pliers, for bending leads, or to hold components in place.
- Small blade and Phillips screwdrivers. A basic range is fine.

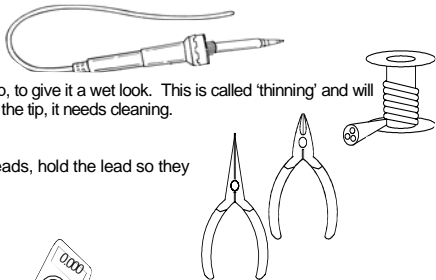

For some projects, a basic multi-meter is required, or might be handy

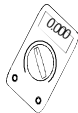

1.2 Assembly Hints :

- ⇒ Make sure the skill level matches your experience, to avoid disappointments.
 - ⇒ Follow the instructions carefully. Read and understand the entire step before you perform each operation.
 - ⇒ Perform the assembly in the correct order as stated in this manual
 - ⇒ Position all parts on the PCB (Printed Circuit Board) as shown on the drawings.
 - ⇒ Values on the circuit diagram are subject to changes.
 - ⇒ Values in this assembly guide are correct*
 - ⇒ Use the check-boxes to mark your progress.
 - ⇒ Please read the included information on safety and customer service
- * Typographical inaccuracies excluded. Always look for possible last minute manual updates, indicated as 'NOTE' on a separate leaflet.

1.3 Soldering Hints :

1- Mount the component against the PCB surface and carefully solder the leads

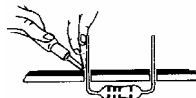

2- Make sure the solder joints are cone-shaped and shiny

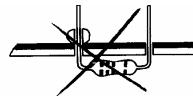
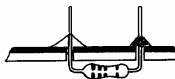

3- Trim excess leads as close as possible to the solder joint

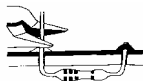

AXIAL COMPONENTS ARE TAPED IN THE CORRECT MOUNTING SEQUENCE !

REMOVE THEM FROM THE TAPE ONE AT A TIME !

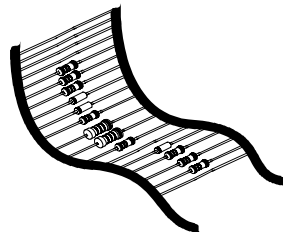

 You will find the colour code for the resistances and the LEDs in the HALG (general manual) and on our website: <http://www.velleman.be/common/service.aspx>

1. Zener diodes. Watch the polarity !

- ZD1 : 11V
- ZD2 : 6V2

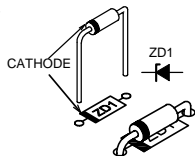

2. 1/2W Resistor

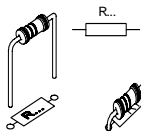

- R1 : 47 (4 - 7 - 0 - B - 9)

3. 1/4W Resistors

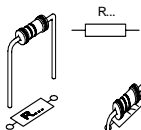

- R2 : 100 (1 - 0 - 1 - B)
- R3 : 560 (5 - 6 - 1 - B)
- R4 : 1K (1 - 0 - 2 - B)
- R5 : 1K (1 - 0 - 2 - B)
- R6 : 1K (1 - 0 - 2 - B)
- R7 : 10K (1 - 0 - 3 - B)
- R8 : 1K5 (1 - 5 - 2 - B)
- R9 : 1K5 (1 - 5 - 2 - B)
- R10 : 1K5 (1 - 5 - 2 - B)
- R11 : 2K7 (2 - 7 - 2 - B)
- R12 : 2K7 (2 - 7 - 2 - B)
- R13 : 2K7 (2 - 7 - 2 - B)
- R14 : 5K6 (5 - 6 - 2 - B)
- R15 : 270K (2 - 7 - 4 - B)

4. Choke.

-
- L5 : 10 μ H (1 - 0 - 0 - A)

5. Capacitors

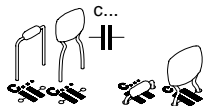

- C1 : 3pF (3.3)
- C2 : 3pF (3.3)
- C3 : 3pF (3.3)
- C4 : 1pF (1, red)
- C5 : 3pF (3.3)
- C6 : 10pF (10)
- C7 : 15pF (15)
- C8 : 22pF (22)
- C9 : 33pF (33)
- C10 : 56pF (56)
- C11 : 100pF (101)
- C12 : 100pF (101)

- ☐ C13 : 180pF (181)
- ☐ C14 : 470pF (471)
- ☐ C15 : 1nF (102)
- ☐ C16 : 1nF (102)
- ☐ C17 : 1nF (102)
- ☐ C18 : 1nF (102)
- ☐ C19 : 1nF (102)

6. Trim capacitor

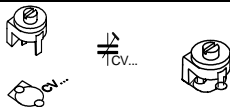

- ☐ CV1 : 5pF

7. Trim potentiometer

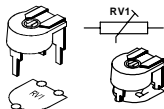

- ☐ RV1 : 50K (47K)
- ☐ RV2 : 1K

8. High frequency inductors

- Cut 3 lengths of the 0.6mm wire supplied to the exact length.
- Scrape the enamel off the ends of each length of wire with a sharp knife for about 5 mm and tin the ends.
- Make up the windings on a gimlet of 3.5mm diameter.

- ☐ L1 : 3 turns Cu 0,6mm (!) - Fig 1.0

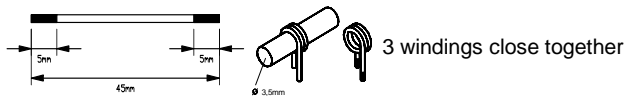

- ☐ L2 : 3 turns Cu 0,6mm (!) - Fig 2.0

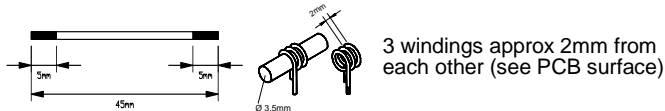

- ☐ L3 : 2 turns Cu 0,6mm (!) - Fig 3.0



9. Transistors

- T1 : BC547B
- T2 : MPSH10
- T3 : MPSH10

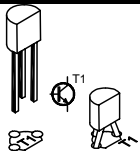

10. Switch.

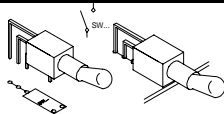

- SW1 : TS - 8

11. DC-jack

- J4 : DJ-005

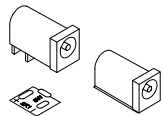

12. RCA connectors

- J1 : Audio
- J2 : Video

13. Electrolytic Capacitors.
Watch the polarity !

- C20 : 4 μ 7
- C21 : 4 μ 7
- C22 : 10 μ F
- C23 : 10 μ F
- C24 : 220 μ F

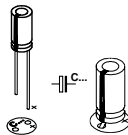

14. High frequency transformer

- L4 : 10,7MHz

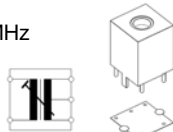

15. Antenna connector

- J3 : RF (!)

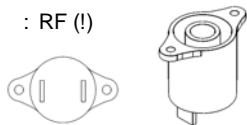

16. LED. Watch the polarity!

- LD1 : Red.

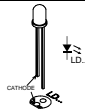

- Connect first the two wires to the spots marked "c" and "a".

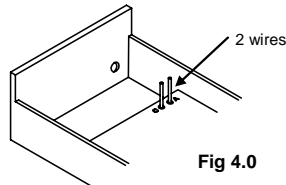

Fig 4.0

- Insert the red LED into the housing as in the drawing.

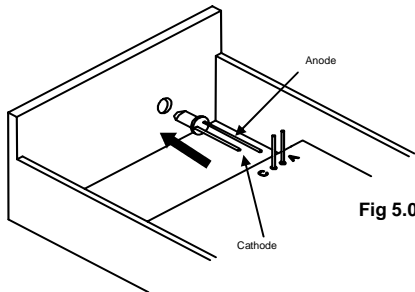

Fig 5.0

☞ Pay attention to the polarity!

- Now connect the two wires with the pins of the LED, respect the polarity!

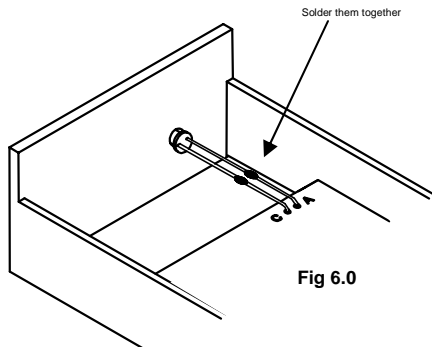

Fig 6.0

17. High frequency transistor

□ T4 :BFR90

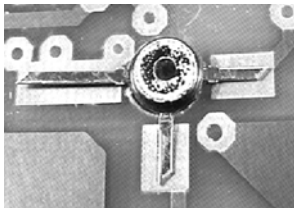

Fig 7.0

Mount the special high frequency transistor along the soldered side, due to length of the leads it is not possible to mount this incorrectly.

18. Fitting inside the housing

- Attach the sticker giving the connection information to the back of the housing.
- Mount the 3 threaded rods on the bottom of the housing, together with a tooth lock washer and M3 countersunk-head bolts (see figure 8.0).
- Mount the PCB on the threaded rods using 3 x M3 bolts.

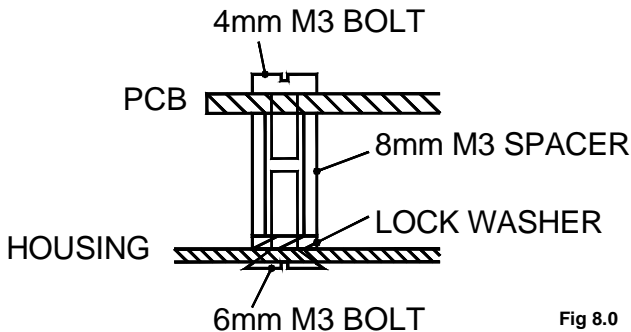

Fig 8.0

19. Test and setup

Preparation:

- Set trimmer potentiometers RV1 (audio) and RV2 (video) to a maximum (completely clockwise).
- Set the frequency trimmer capacitor, CV1, to the middle of its range.
- Carefully turn the core of L4 completely down using a suitable screwdriver.
- Put the housing cover into place.
- Connect a video and audio signal to the inputs of the modulator
- Using a cable and connectors, connect the antenna output of the modulator to the antenna input of the TV set, or connect a 30cm length of stiff wire to the modulator antenna connector.



ATTENTION: As soon as an antenna is connected to the modulator, it becomes a transmitter which is prohibited in some countries.

- Connect a supply voltage (adaptor) of between 12 and 15 VDC to the supply voltage connector. Check the polarity, the edge of the connector must be negative.
- Set the modulator switch to ON. The control LED should now light up.

Adjusting the picture:

- Set the TV set to "search" on the UHF band until a clear picture is obtained. If a clear picture cannot be obtained then try turning the trimmer capacitor to a different setting (turn 1 to 2 mm per test).
- "Expand" or "compress" (see fig. 9.0) also have an influence on the picture quality, and it is always necessary to close the housing before doing the test (if the test is done with an open housing then the settings will probably have to be done again after the cover has been put in place).

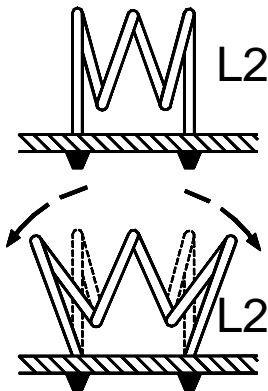

Fig 9.0

- The modulation of the video signal can be further adjusted using trimmer potentiometer RV2.
- ☞ **NOTE:** The above instructions for setting the received picture are only guidelines. A little experimentation with the setting of the frequency capacitor, CV1, and also variations in inductor L2 and potentiometer RV2 can greatly improve the picture quality.

Setting the sound:

- Once a good picture has been obtained the sound carrier can be set.
- Carefully turn the core of L4 with a suitable screwdriver, until the background noise is suppressed and a normal sound can be heard.
- The audio modulation can be further adjusted using RV1 (with overmodulation distortion becomes audible).

The modulator is now ready for use

20. DIAGRAM

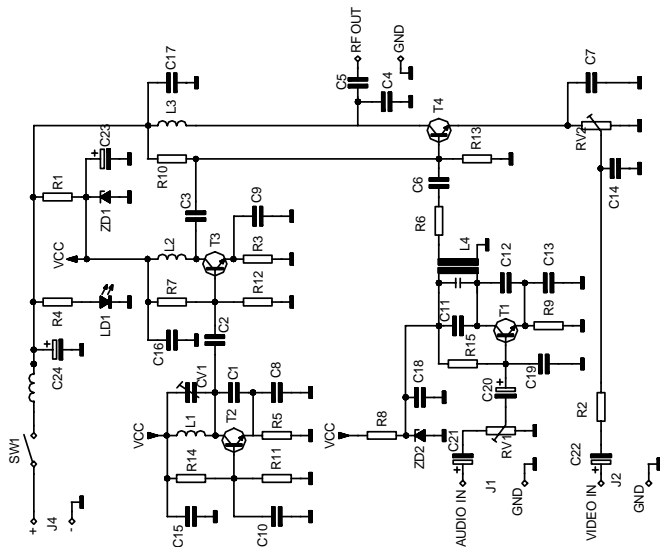

21. PCB

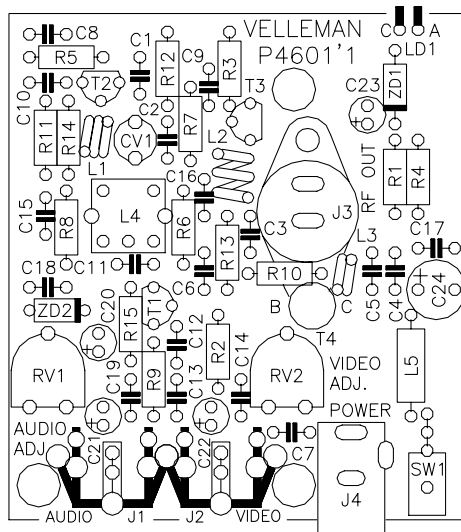



Modifications and typographical errors reserved
© Velleman Components nv.
H4601IP - 2004 - ED2

