

Total solder points: 95

Difficulty level: *beginner* 1  2  3  4  5  *advanced*

# UNIVERSAL AC MOTOR CONTROL



## *K2636*

*Easy speed control of AC collector  
motors.*

This kit is especially designed to control the speed of drills or any other AC-motors with carbon brushes. Contrary to the usual dimmers, there isn't a phase cut every 1/2 period but only once per period. The moment of cutting determines the speed which can be adjusted from 5 to about 95 %. Owing to this kind of controlling, we keep a higher torque at low speed. This does not mean on the other hand, that this circuit cannot be used for a resistive load (e.g. lamps, heating devices.).

### **A few advantages are :**

- The control range is from 5 % to 95 %.
- There is an anti-RF interference circuit included.
- The triac is protected against inductive voltage peaks from the motor.
- The control circuit is powered by the mains, but the load supply may be derived from a different AC source. Both voltages should have the same frequency though, and they should have completely the same phase or the opposite phase (derived from one and the same phase out of the 3-Phase power source).
- By keeping the MAINS- and LOAD SUPPLY separated this circuit is extremely appropriate for the use in low voltage applications: e.g. in swimming pools, outdoors ...

### **Specifications**

- Power voltage :
  - MAINS 220-240 VAC or 125 VAC
  - LOAD SUPPLY 24VAC to 240VAC
  - MAINS AND LOAD SUPPLY are galvanically separated
- Max. power to be regulated : 1200W at 240V (max. 5A).
- Control range : 5 to 95 %.
- Separate adjustment for the lowest speed.
- Anti-RF interference circuit included.
- Dimensions : 130 x 75 x 55mm.

## 1. Assembly (Skipping this can lead to troubles !)

Ok, so we have your attention. These hints will help you to make this project successful. Read them carefully.

### 1.1 Make sure you have the right tools:

- A good quality soldering iron (25-40W) with a small tip.
- Wipe it often on a wet sponge or cloth, to keep it clean; then apply solder to the tip, to give it a wet look. This is called 'thinning' and will protect the tip, and enables you to make good connections. When solder rolls off the tip, it needs cleaning.
- Thin raisin-core solder. Do not use any flux or grease.
- A diagonal cutter to trim excess wires. To avoid injury when cutting excess leads, hold the lead so they cannot fly towards the eyes.
- Needle nose pliers, for bending leads, or to hold components in place.
- Small blade and Phillips screwdrivers. A basic range is fine.

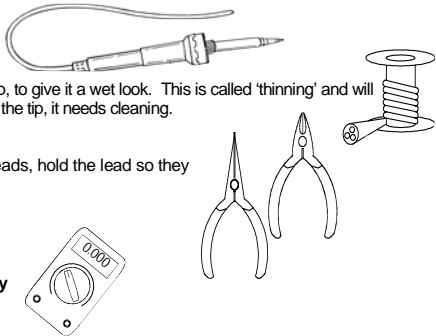

**For some projects, a basic multi-meter is required, or might be handy**

### 1.2 Assembly Hints :

- ⇒ Make sure the skill level matches your experience, to avoid disappointments.
  - ⇒ Follow the instructions carefully. Read and understand the entire step before you perform each operation.
  - ⇒ Perform the assembly in the correct order as stated in this manual
  - ⇒ Position all parts on the PCB (Printed Circuit Board) as shown on the drawings.
  - ⇒ Values on the circuit diagram are subject to changes.
  - ⇒ Values in this assembly guide are correct\*
  - ⇒ Use the check-boxes to mark your progress.
  - ⇒ Please read the included information on safety and customer service
- \* Typographical inaccuracies excluded. Always look for possible last minute manual updates, indicated as 'NOTE' on a separate leaflet.

### 1.3 Soldering Hints :

1- Mount the component against the PCB surface and carefully solder the leads

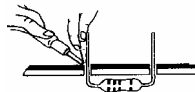

2- Make sure the solder joints are cone-shaped and shiny

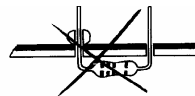
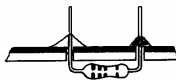

3- Trim excess leads as close as possible to the solder joint

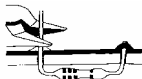

REMOVE THEM FROM THE TAPE ONE AT A TIME !

**AXIAL COMPONENTS ARE TAPED IN THE  
CORRECT MOUNTING SEQUENCE !**

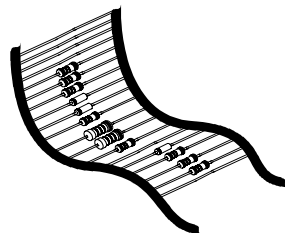

 You will find the colour code for the resistances and the LEDs in the HALG (general manual) and on our website: <http://www.velleman.be/common/service.aspx>

### 1. Jumper.

Mount jumper according to the main voltage :

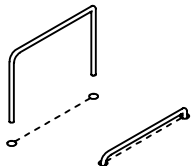

- J1 : 220V
- J2 : 125V

### 2. Diodes. Watch the polarity !

- D1 : 1N4007
- D2 : 1N4007
- D3 : 1N4148
- D4 : 1N4148
- D5 : 1N4148
- D6 : 1N4148
- D7 : 1N4007

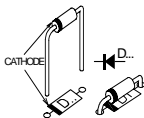

### 3. Resistors

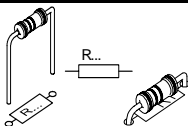

- R1 : 4K7 (4 - 7 - 2 - B)
- R2 : 3K3 (3 - 3 - 2 - B)
- R3 : 680 (6 - 8 - 1 - B)
- R4 : 22K (2 - 2 - 3 - B)
- R5 : 22K (2 - 2 - 3 - B)
- R6 : 1K5 (1 - 5 - 2 - B)

Choose operating frequency :

Europe (50Hz)

- R7 : 47K (4 - 7 - 3 - B)

US (60Hz)

- R7 : 10K (1 - 0 - 3 - B)

- R8 : 100K (1 - 0 - 4 - B)
- R12 : 1K (1 - 0 - 2 - B)

### 4. Metal film resistors

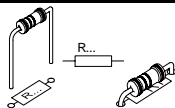

- R9 : 100 (1 - 0 - 1 - B - 9)
- R10 : 120 (1 - 2 - 1 - B - 9)
- R11 : 68 (6 - 8 - 0 - B - 9)
- R13 : 27 (2 - 7 - 0 - B - 9)
- R14 : 390K (3 - 9 - 4 - B - 9)

### 5. Capacitor

- C3 : 100nF (104)



### 6. Trim potentiometer

- RV2 : 100K

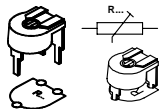

## 7. Transistors.

- T1 : BC547B
- T2 : BC547B
- T3 : BC547B
- T4 : **BC517**

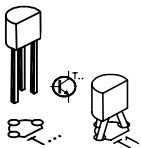

## 8. Capacitors

- C5 : 47nF
- C6 : 100nF/400V
- C7 : 47nF/400V

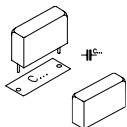
9. Electrolytic Capacitors.  
Watch the polarity !

- C1 : 470 $\mu$ F
- C2 : 1 $\mu$ F

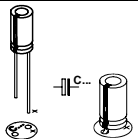

## 10. Terminal blocks.

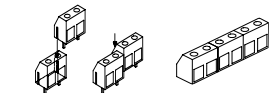

- VAC : 2p
- LOAD : 2p
- MAINS : 2p

## 11. Fuse holders + fuses

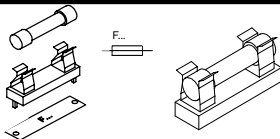

- F1 : 250mA (slow)
- F2 : 5A (slow)

## 12. Trim potentiometer

- RV1 : 100K

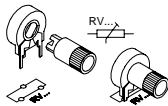

## 13. Coil.

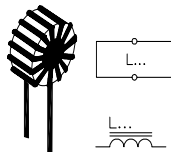

- L1 : 50 $\mu$ H / 1kHz

## 14. Transformer

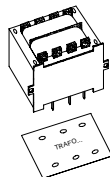

- TRAF01 : 2 x 6V / 1 x 0,3A

☞ Mount the 6V connections to the OUTSIDE of the print !

## 15. Triac.

□ TRI1: BT137F-600

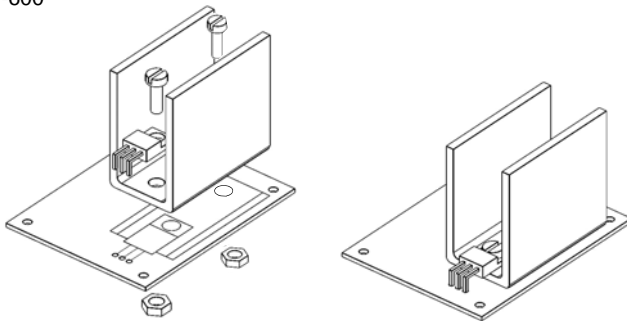

- Place the heatsink and the triac on the PCB.
- ☞ Ensure that the hole of the heatsink and the one of the triac correspond to the hole in the PCB.
- Fix the two components with 2 M3 bolts and 2 nuts.
- Now, the triac may be soldered.

## 16. Test & connection

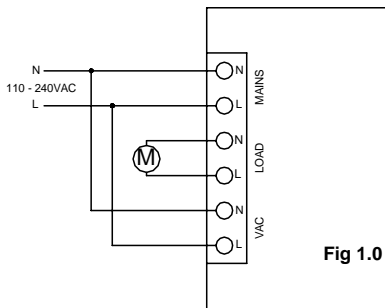

Fig 1.0



### ATTENTION:

A PART OF THE CIRCUIT IS ALWAYS UNDER MAIN VOLTAGE. TAKE ALL POSSIBLE PRECAUTIONS, SO THAT NO-ONE CAN TOUCH ANY PART. FOR YOUR OWN SECURITY AS FOR THE USERS' SECURITY. MOUNT THIS KIT PREFERABLY IN AN ISOLATING HOUSING. THE FUSE WILL MELT IN CASE OF AN OVERLOAD, REPLACE IT BY EXACTLY THE SAME TYPE.

- Connect the load to the screw connector marked by "LOAD" see fig. 1. Consider the max. load (5,5A)
- Connect the mains voltage on the screw connector "MAINS".

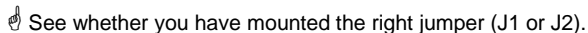
 See whether you have mounted the right jumper (J1 or J2).

- The power voltage for the load is put on the connector. "VAC" (24 ... 240VAC).

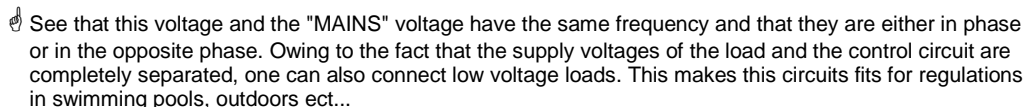
 See that this voltage and the "MAINS" voltage have the same frequency and that they are either in phase or in the opposite phase. Owing to the fact that the supply voltages of the load and the control circuit are completely separated, one can also connect low voltage loads. This makes this circuits fits for regulations in swimming pools, outdoors ect...

- Turn RV1 completely to the left (minimal position) and RV2 completely to the right.
- Switch the power on.

 **BE CAREFUL:** a large part of the circuit is under mains power, do not touch it!

- Adjust RV2 so that the motor will have the lowest speed. It is important for the motor to start at any time, even where RV1 is put in its minimal position, otherwise there might be large currents causing sparks that burn the carbon brushes.

 **NOTE:** If the torque is poor, swap the two wires, connected to "VAC", mutually. The connections to "MAINS" must remain un-changed!

## 17. PCB

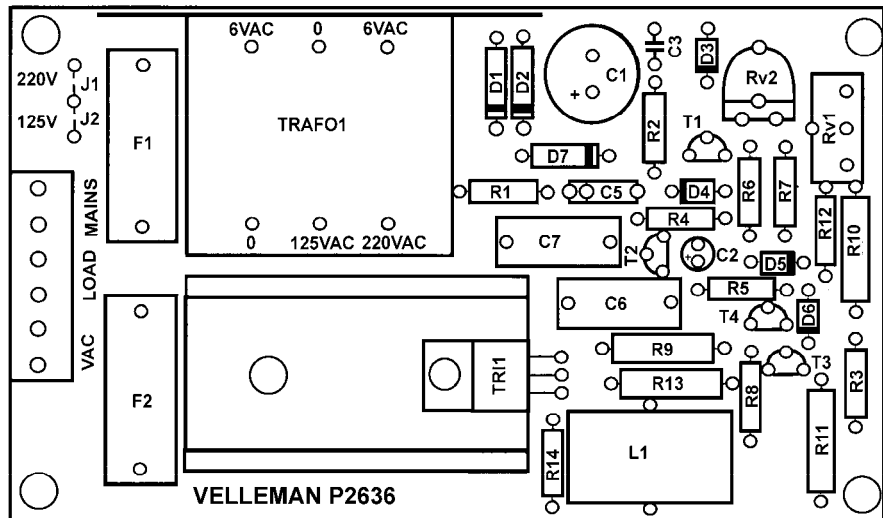





Modifications and typographical errors reserved

© Velleman Components nv.

H2636IP - 2004 - ED1

